

HOHMANN & BARNARD, INC.

INNOVATIVE PRODUCTS FOR THE MASONRY INDUSTRY

Masonry Joint Reinforcement

Thermal Veneer Anchors

Air & Vapor Barrier Systems

Concealed Lintel Systems

Seismic Veneer Anchors

Flashing Systems

Masonry Cleaning Systems

High Strength Systems

Stone Anchoring Systems

Restoration Anchoring Systems

CUSTOM METAL FABRICATION



LEADING THE INDUSTRY SINCE 1933

A BRIEF HISTORY OF ADJUSTABLE JOINT REINFORCEMENT

Adjustable joint reinforcement was developed decades ago to address several major complications that arose when using standard joint reinforcement across multi-wythe walls. The main obstacle was that when the interior CMU wall was built prior to constructing the exterior brick masonry wall the joint reinforcement in the interior wall would project out of the wall for weeks or months until the construction of the exterior wall. This practice created a potential safety hazard for masons and other workers, while leaving the wire unprotected in a construction environment. The wire would often get disfigured, occasionally cracking its protective zinc coating.

The battered wire was difficult to lay flat onto the brick and the mason often had to bend the wire to install the face brick and apply the mortar. Once installed, standard masonry joint reinforcement didn't offer the structural value that is now deemed optimal for transferring loads from the exterior wall to the interior wall. The continual movement of the exterior wall due to wind loads, etc., caused overstressing of the cross wire of the joint reinforcement, degrading wall performance. The use of standard joint reinforcement across multi-wythe walls was NOT user-friendly, safe, or particularly effective for the mason to construct his walls. These complications ushered in the use of adjustable joint reinforcement.

"Hook-and-eye" adjustable joint reinforcement became the industry standard. Hook-and-eye reinforcement consists of either truss or ladder joint reinforcement with factory-welded eyelets at 16" o.c., combined with "hooks" or "pintles" which engage the eyelets and install into the mortar joint of the face brick. The system allowed independent construction of interior and exterior walls, eliminating many of the deficiencies of non-adjustable joint reinforcement. It was

also user-friendly, the hooks were simply slipped into the eyelets as they were placed into the mortar bed of the brick. Hook-and-eye also performed better than simple non-adjustable joint reinforcement, as there was a more efficient transfer of wind loads to the CMU and the structure of the building. Thus, hook-and-eye wire was a great success, relegating non-adjustable truss or ladder reinforcement to single wall construction, or solid composite wall construction.

As masonry construction became more sophisticated and more emphasis was placed on the strength and durability of masonry walls, Hohmann & Barnard's design team realized that the performance of adjustable joint reinforcement could be improved. Consequently, H&B's Dub'l Loop-Lok[®] system was developed with a unique "loop" design. This design offered numerous performance enhancements beyond typical hook-and-eye systems:

- Allowed in-plane vertical and horizontal movement of masonry wythes, while restraining tension and compression.
- Loops were welded shut to maintain allowable tolerance and system integrity.
- Foolproof. The wire tie could NOT be installed beyond allowable eccentricity.
- Provided 100% protection against separation of wire tie from reinforcement. (TMS 402-13/ACI 530-13/ASCE 5-13).
- The vertical configuration of loops was not susceptible to clogging with mortar as construction progressed.

Many architects and designers of masonry walls quickly realized the advantages that this product offered compared to standard hook-and-eye wire. Thus, H&B's Dub'l Loop-Lok gained wide acceptance and specification on projects around the United States including a variety of federal, state and local government projects.

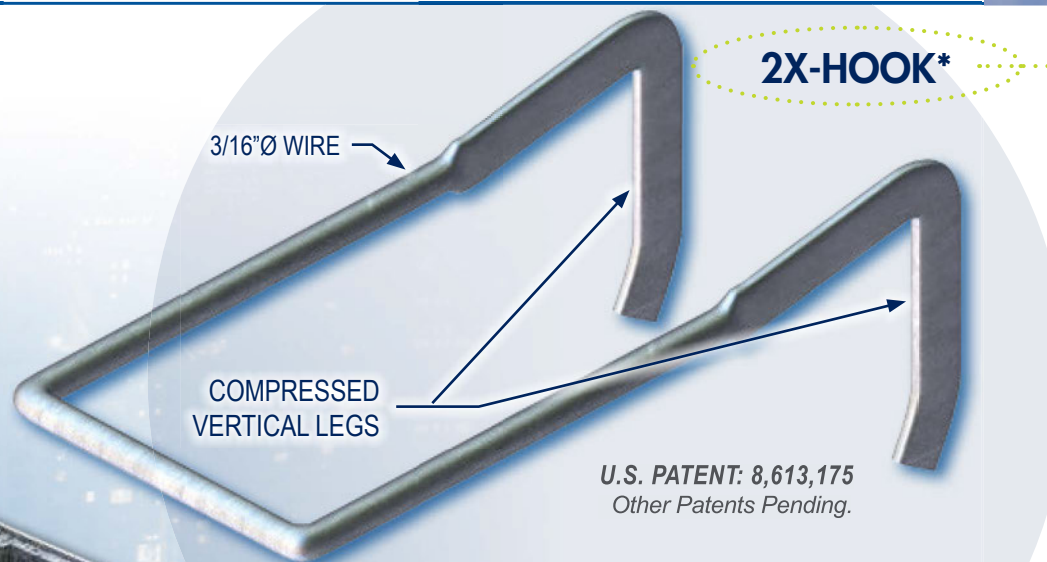
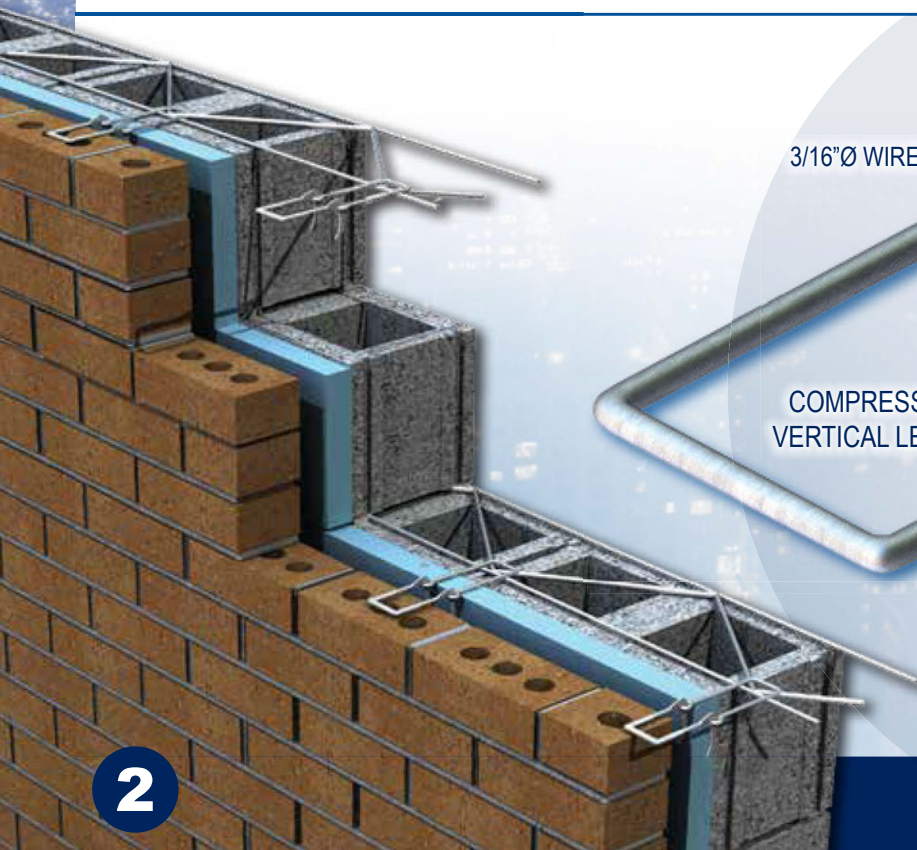

For Submittals, MSDS & CAD visit:
www.h-b.com/170 or www.h-b.com/270

* Contact Hohmann & Barnard for independent lab test results

THE LATEST DEVELOPMENTS FROM HOHMANN & BARNARD

With continued investment into state-of-the-art machinery and tooling, Hohmann & Barnard has once again responded to the needs of the design and architectural community by offering even more enhancements to its well-established Eye-Wire and Dub'l Loop-Lok[®] adjustable wall reinforcement products.

EYE-WIRE REDESIGNED:

170 TRUSS & 270 LADDER SYSTEMS

featuring the **2X-HOOK**

Testing has established that the engagement of the hook into the eyelet is the weakest link in a typical adjustable eye-wire system. Increasing the vertical eccentricity between the hook and the eyelet further weakens the system. The load values that develop using typical 3/16" diameter wire require that the engagement of the hook into the eyelet should be offset by no more than 1-1/4" (under typical wind loads) before the assembly becomes too weak to sufficiently transfer the loads to the backup block and the structure of the building. Considering these factors the TMS 402-13/ACI 530-13/ASCE 5-13 Code specifies a maximum eccentricity of 1-1/4". The traditional use of 3/16" diameter wire to fabricate the hook has been a primary reason for this limitation. The 3/16" diameter wire has traditionally been used to fabricate hooks because they accommodated code requirements that specify the typical mortar bed (3/8") must be twice the diameter of the wire. In addition, they were cost effective and they offered suitable performance at optimal and near-optimal engagement. Unfortunately, the maximum eccentricity of 1-1/4" of typical 3/16" hooks could present tolerance problems during installation under actual jobsite conditions.

Hohmann & Barnard has developed an innovative hook design that features strength over 100% greater than that of a standard hook, while still being fabricated from standard 3/16" diameter wire. As shown in the image on the left, the new hook features a compressed vertical leg, a precision .020" inside radius at the bend, and the flattened portion itself is machine-tooled to be exactly centered between the still rounded outer edges. Independent lab tests* have confirmed that these new design features provide superior resistance to lateral loads. Therefore the new H&B 170 and 270 hook-and-eye can be used on projects with more demanding load requirements and still satisfy maximum deflection recommendations as indicated by the Brick Industry Association Technical Note 44B.

"Specify ties with maximum deflections of less than 0.05 in., or 1.2 mm, when tested at an axial load of 100 lbs. in tension or compression at maximum offset of 1 1/4" eccentricity."

Hohmann & Barnard's new hook and eye actually tested at over 200 lbs. in tension or compression, exceeding BIA recommendations by over 100%, creating a higher standard for the masonry industry.

In the past, engineers and designers would often address the 1-1/4" maximum eccentricity problem by specifying 1/4" diameter hooks to strengthen the tie, but this raises the issue of code requirements for mortar thickness to be twice the diameter of the wire tie or hook. H&B has solved this problem, offering more than twice the strength of a typical hook while still maintaining a code-complying 3/16" diameter.

Hohmann & Barnard is offering this superior product at prices competitive with the typical hook-and-eye wire.

All the benefits at little to no extra cost.

MIGHTY-LOK[®] HOOK

There are still conditions that can only be addressed with a heavy-duty 1/4" diameter hook. Extraordinary loads that are the result of a larger than normal vertical eccentricity of hook/eyelet engagement, extremely wide air cavities, or usage in regions with a propensity to experience hurricanes or occasionally severe wind loads are examples where 1/4" diameter wire is necessary. H&B had already manufactured a unique, patented 1/4" diameter hook, the Mighty-Lok[®] Hook, with a flattened and serrated end that made it suitable for a typical 3/8" mortar joint (refer to image below). H&B has enhanced the original Mighty-Lok[®] Hook with a compressed leg design that increases the strength of the hook by 30% and still features the flattened and serrated end for engagement into the mortar joint of brick veneer, as shown in the illustration below. The vertical legs are sized to offer 2-1/4" effective adjustability.

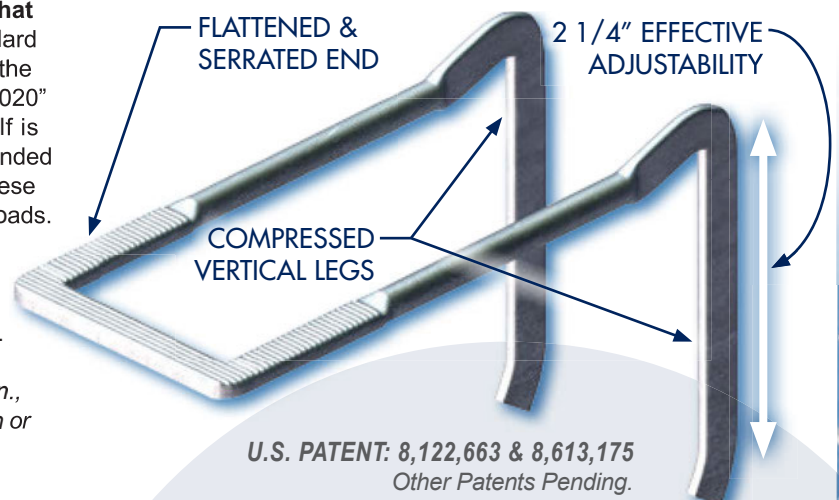

MIGHTY-LOK[®] FLAT-HOOK*

Contact H&B for the design parameters for usage of the 1/4" diameter Mighty-Lok[®] hook.

* Contact Hohmann & Barnard for independent lab test results

2X STRONGER THAN THE INDUSTRY STANDARD

**REDESIGNED DUB'L LOOP-LOK®:
180-HS TRUSS & 280-HS LADDER**

H&B has also modified the design of the “loops” of its Dub'l Loop-Lok® Adjustable reinforcement. This upgrade dramatically increases the working loads of the reinforcement and offers 2-1/4 inches of vertical adjustability. Furthermore, the new loop design maintains all of the features of the original Dub'l Loop-Lok listed earlier in this report.

As shown above, the original Dub'l Loop-Lok's design principle of having loops oriented vertically remains intact. However, through new state-of-the-art machining, the 3/16" diameter wire has now been flattened (and strengthened) along the entire vertical loop and the horizontal leg. The horizontal leg portion is also strengthened by having the legs doubled-up and welded together. This generates load values previously impossible in adjustable reinforcement of any kind, using 3/16" diameter adjustable ties.

The new vertical loop provides over **100% more strength*** than our original Loop-Lok and comparable vertical loop systems in resisting tension and compression from wind loads, while the horizontal leg portion is uniquely resistant to upward and downward deflection even when resisting the substantial loads generated in wall designs featuring extra wide insulation. Dub'l Loop-Lok performs better than any other adjustable reinforcement system on the market today.

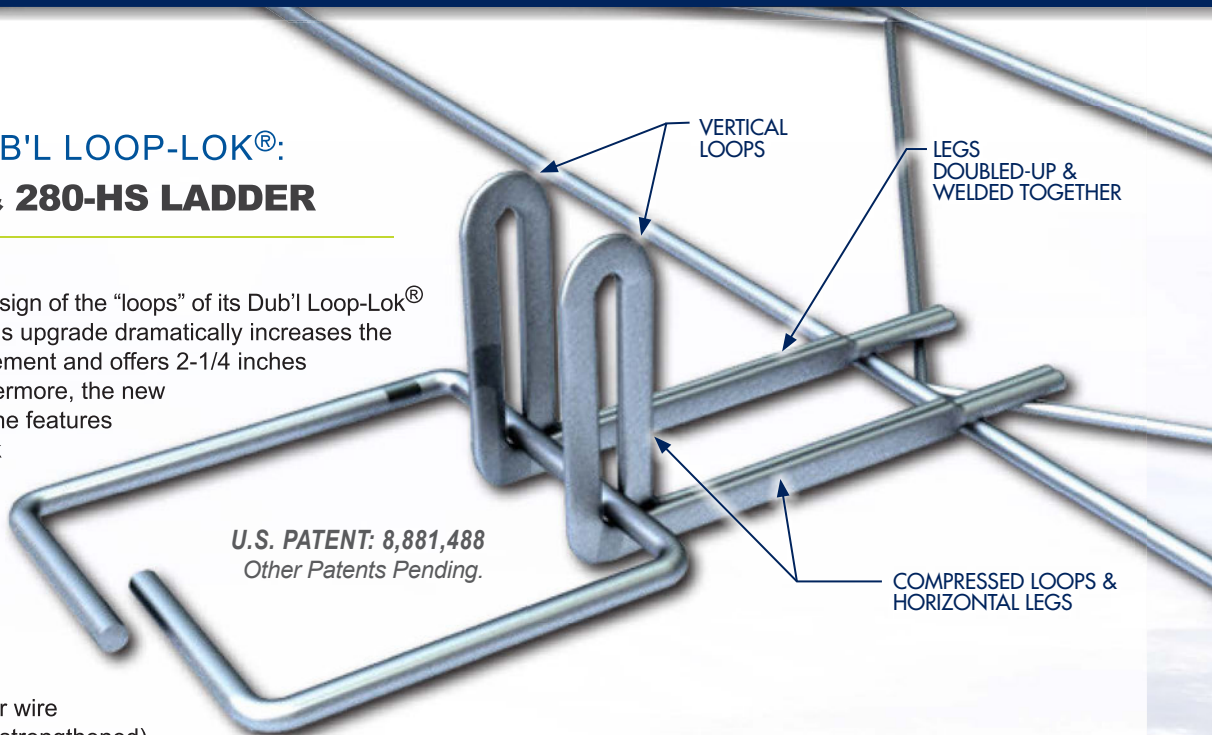

U.S. PATENT: 8,881,488
Other Patents Pending.

VERTICAL
LOOPS

LEGS
DOUBLED-UP &
WELDED TOGETHER

COMPRESSED LOOPS &
HORIZONTAL LEGS

* Contact Hohmann & Barnard, Inc. for independent lab test results

**FOR MORE INFORMATION
ON ADJUSTABLE REINFORCEMENT SYSTEMS**

Lox-All® Reinforcement with 2X-Hook	7
180-BL with Byna-Lok® Tie	8
Mighty-Lok® Reinforcement	9
HB-213-HS with Mighty-Lok® Flat Hook	9
HB-213 Series with 2X-Hook	11



Lox-All Truss & Ladder Reinforcement	
#120 - #140 Truss / #220 - #240 Ladder *●	6
#220 Glass Block Reinforcement *●	6
#165 & #170 Adjustable Truss *●	7
#265 & #270 Adjustable Ladder *●	7
Adjustable Wall Ties, SH-Seismic Hook *●	7
Adjustable Reinforcement Systems	
#180-HS & #280-HS Ladder w/ Byna-Lok® Wire Tie*●	8
Mighty-Lok® Truss & Ladder Reinforcement *●	9
HB-213-HS with Mighty-Lok® Flat Hook *●	9
Tie-2R, Tie-HVR-190V, Tie-HVR-195V, Tie-HVR-195VB*●	10
Veneer Anchor Systems	
HB-213, HB-200-X, 5213	11
X-Seal® Anchor, 2-Seal Tie™	12
Fire Resistant Thermal 2-Seal™ Anchors	13
Column And Beam Anchors	
#353, #353L, #354, #355L & #357 ●	14
Column & Weld-On Ties	
#351 & #352 Wire Column Ties *●	14
#359, #359-C, #359FP, #359FP-C, #359FH, #301W, #302W *●	15
BL-407 Brick Veneer Anchor	15
Self-Drilling/ Self-Tapping Screws	15
Seismic Veneer Anchors	
#303 SV, #345 SV, #364 SV & HB-213S	16
Channel-Tee Seismic-Notch System	16
Gripstay Anchor Systems	
#362-CX, #360-#362, #362-C Gripstay Channels	17
#363 & 363-BL Flexible Gripstay *● #365 Bent Gripstay Anchor	17
Wall Ties and Anchors	
Byna-Lok® Tie / Vee Byna-Tie® *●	18
S.I.S - Seismiclip® Interlocking System	18
DW-10HS® / DW-10HS® with Byna-Lok® Tie	18
#315, #315-BT, #315-BL Flexible Dovetail Anchors *●	19
#345-BT, #345-BL Flexible Ties *●	19
Miscellaneous Accessories	
Slip-Set Stabilizer, #344 Rigid Partition Anchor ●	20
Corrugated Wall Tie, Corrugated Control Joint	20
Mesh Wall Tie, Mortar/Grout Screen	20
Rebar & Scaffolding Accessories	
Spyra-Lox Lap-Joint Tie *●	21
RB & RB Twin Rebar Positioners, *● Rebar Caps, Scaffold Clips	21
PTA Series Partition Top Anchors	22
Concrete Inserts	23
Sharktooth & CSH Inserts	24
Concealed Lintel Systems for Brickwork	25
Specialty Laser Cutting	26
Stone Anchors & Accessories ●	27

*New and improved products listed in Red.

Who ever said, it's not easy being green? Just look for the 'green dots' throughout the catalog for info on recycled content.



Blok-Lok Restoration Systems	
Torq-Lok® Mechanical Restoration Anchors	28
Panel-Lok® Restoration Anchors for Stone Veneer	29
Spira-Lok® Restoration Helical Wall Tie System	30
Diedrich Masonry Cleaning Systems	
202 & 202V New Masonry Cleaners	31
333 Omegaseal, Salt-Bloc™ Barrier	32
101, Envirestore™ 100,	
707X Limestone Restoration	33
606, 505 Paint Removers / 960 Concrete Cleaner	34
Flashing Systems	
Textroflash™ ● Nuflex™ PVC Flashing	35
Flex-Flash® Flashing and Drip Edge	36
Mighty-Flash™ SA Stainless Steel Fabric Flashing ●	37
Copper-Fabric™ SA, Copper-Fabric™ NA	38
C-Fab™, C-Coat™, C-Kraft™ Copper Flashings	39
Epra-Max™ EPDM Flashing	39
Metal Flashings / Metal Inside & Outside Corners ●	40
Drip Plates & DP Corners ●	41
Corners & End Dams / Termination Bar ●	42
Primer SA™ & HB Sealant	42
Weep Holes, ● Quadro Vent	43
Mortar Web™, Mortar Trap™ ●	43
Air Barrier Systems	
ENVIRO-BARRIER™ / ENVIRO-BARRIER™ VP	
Fluid Applied Air and Vapor Barrier Products ●	44
X-Barrier™ Peel & Stick Barrier ●	45
ENVIRO-BARRIER™ Mastic ●	45
Stretch-X-Seal™ Window Pan Flashing ●	46
X-Seal® Membrane ●	46
Aluminum Brick Vents ●	47
Expansion and Control Joints	
Neoprene Sponge, Bearing Pads ●	48
Rubber Control Joints / PVC Control Joints ●	48
Backer Rod / Soft Rod	49
Removable Expansion Joint Cap	49
Standard Cork / Self-Expanding Cork ●	50
Material Conformance Data	51

IMPORTANT: Since each construction project is unique, the appropriate selection and use of any product contained herein must be determined by competent architects, engineers and other appropriate professionals who are familiar with the specific requirements of the project in question.

LOX-ALL® REINFORCEMENT ●

TRUSS Type

LADDER Type

120 Truss-Mesh

Single Wythe Wall

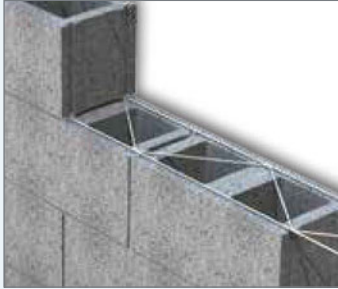

220 Ladder-Mesh

Single Wythe Wall



130 Truss-Tri-Mesh

Composite Wall



230 Ladder-Tri-Mesh

Cavity Construction

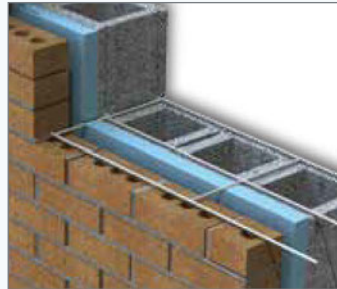

140 Truss-Twin-Mesh

Composite Wall



240 Ladder-Twin-Mesh

Cavity Construction



Hohmann & Barnard's Lox-All® Truss-Mesh and Ladder-Mesh are continuous lengths of joint reinforcement that are embedded into the horizontal mortar joint of masonry walls. Joint reinforcement has long proven to be necessary for superior performance of masonry wall construction.

Benefits:

- Greatly reduces cracking that can arise from thermal stresses. This enhances resistance to water penetration, as cracks are controlled.
- Increases lateral flexural strength.
- Bonds exterior and interior masonry wythes together in composite or cavity walls. Also bonds masonry at intersecting walls and corners.
- Increases elasticity and performance of masonry walls under various stresses.

Features:

- Butt-welding of cross rods to longitudinal rods (not more than 16" o.c.). This construction enhances bonding capabilities, eliminates projection of cross rods beyond the specified width of reinforcement, and prevents excessive height of wire in limited mortar joints.
- Continuous deformation along each longitudinal rod for superior bonding performance.

(S) Standard: 9 ga. side rods x 9 ga. cross rods.

(EH) Extra Heavy: 3/16" side rods x 9 ga. cross rods.

(SHD) Super Heavy Duty: 3/16" side rods x 3/16" cross rods.

Finishes: Mil Galvanized, Hot Dipped Galvanized, and Stainless Steel.

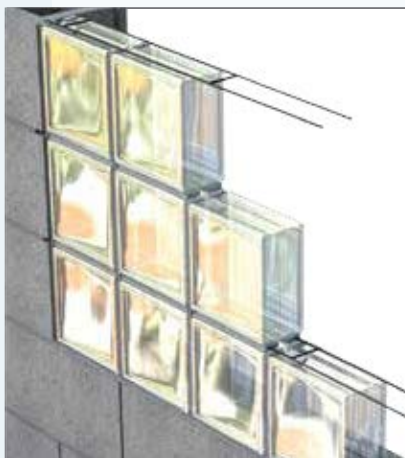

220 GLASS BLOCK Reinforcement

Continuous lengths of joint reinforcement that are embedded into the horizontal mortar joints of glass block walls.

- Butt-welding of cross rods to longitudinal rods (not more than 16" o.c.). This construction enhances bonding capabilities, eliminates projection of cross rods beyond the specified width of reinforcement, and prevents excessive build up of wire in limited mortar joints.
- Continuous deformation along each longitudinal rod for superior bonding performance.

Standard Sizes:

- 1-5/8" or 2" wide
X 4' or 10' lengths.
- 9 ga. side rods
x 9 ga. cross rods.

Finishes:

- Mil Galvanized.
- Hot Dipped Galvanized.
- Stainless Steel.

LOX-ALL® ADJUSTABLE REINFORCEMENT

2 Products on this page feature the NEW 2-HOOK with over 100% more strength than traditional ties. See pages 2-3 for more information on this innovative new product!

TRUSS Type

165 Adjustable Truss
Cavity / Insulated Wall



170 Truss LOX-ALL®
Adjustable Eye-Wire

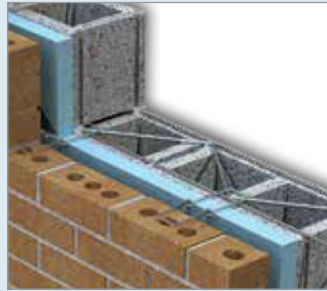

H&B manufactures its stainless steel wire from a minimum of **95%** recycled materials.

165 & 265 - have horizontal "winged loops" welded to the back-up reinforcing. The loops accept 2X-HOOK pintles to allow vertical adjustability while restraining transverse movement of the two wythes. Suitable for collar joint conditions, cavity walls or insulated walls.

170 & 270 LOX-ALL® Adjustable Eye-Wire

- Same features as above, with eyelets in lieu of loops.
- Pintle drops into snug eyelet as exterior wall is erected, tying both wythes together.
- Allows construction of interior wythe in advance of exterior wythe.
- Special design of pintle serves to mechanically secure insulation to the masonry back-up.

LADDER Type

265 Adjustable Ladder
Cavity / Insulated Wall



270 Ladder LOX-ALL®
Adjustable Eye-Wire



Standard Sizes: 4" wall - 16" wall. Other widths available on special request. Adjustable reinforcing made to accommodate various insulation / air dimensions. Eyes and Pintles are 3/16" dia.

(S) Standard: 9 ga. side rods x 9 ga. cross rods.

(EH) Extra Heavy: 3/16" side rods x 9 ga. cross rods.

(SHD) Super Heavy Duty: 3/16" side rods x 3/16" cross rods.

For seismic conditions add **"-SH"** to any product number.

Example: 270-SH

Finishes: Hot Dipped Galvanized, Stainless Steel Type 304 or 316.

U.S. Patent: 8,613,175. Other Patents Pending.

Adjustable Wall Ties



SH - Seismic Hook

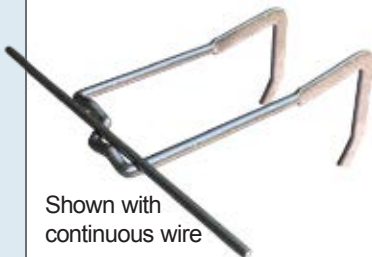

Shown with continuous wire



PINTLE SECTION:

STANDARD HOOK					
TIE NO.	300H	400H	500H	600H	700H
SIZE	3"	4"	5"	6"	7"

SEISMIC HOOK

EYE SECTION:

STANDARD OR SEISMIC HOOK				
TIE NO.	275E	350E	475E	575E
SIZE	2 3/4"	3 1/2"	4 3/4"	5 3/4"

Finishes:

- Hot Dipped Galvanized
- Type 304 or Type 316 Stainless Steel

H&B'S SEISMIC HOOK is "swaged" (indented) in two places to accommodate either a 9 gauge or 3/16" continuous wire. As shown, a channel is formed that braces the continuous wire and holds it in place. Suitable for standard 3/8" joints.

Specify Seismic Hook with any adjustable wire, such as the 170-SH.

Finishes: Hot Dipped Galvanized and Stainless Steel.

U.S. Patents: 6,789,365; 7,325,366; 8,096,090 & 8,613,175
Other Patents Pending

HOHMANN & BARNARD's wire products conform to ASTM A 951 standard specifications for masonry joint reinforcement

ADJUSTABLE REINFORCEMENT SYSTEMS

180-HS TRUSS

with Byna-Lok® Wire Tie

180-HS Truss Features:

100% protection against separation of wire tie from reinforcement.
(See Code TMS 402-13/ACI 530-13/ASCE 5-13)

Allows in-plane vertical and horizontal movement of masonry wythes while restraining tension and compression.

Loops welded shut to maintain allowable tolerance and system integrity.

Unlike horizontal eyelets, vertical loops will not clog with mortar as construction progresses.

Loop extends one direction only to allow simple placement of insulation. Slip on Loop-Lok™ Washer to mechanically lock insulation in place.

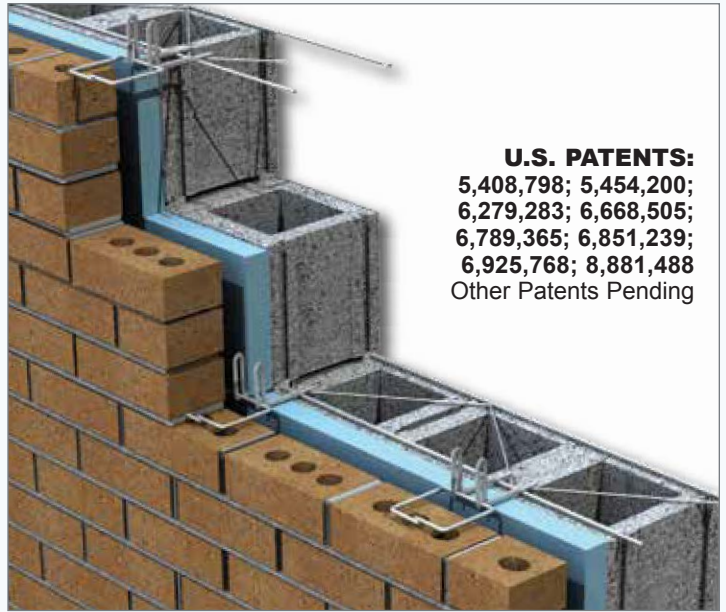

U.S. PATENTS:
 5,408,798; 5,454,200;
 6,279,283; 6,668,505;
 6,789,365; 6,851,239;
 6,925,768; 8,881,488
 Other Patents Pending

Also available: **280-BL** Ladder Style

Byna-Lok® Features:

Swage and mild pitch on legs of the Byna-Lok® Wire Tie provide an integral track for the continuous joint reinforcement wire.

Economical. Add continuous wire to masonry walls at little additional cost.

Suitable for standard 3/8" mortar joint.

The use of continuous wire in the outer brick wythe is beneficial in providing protection against problems arising from thermal expansion and contraction (crack control). It also allows for a more uniform distribution of lateral forces. Suitable for Seismic Zones.



H&B manufactures steel wire products from a minimum of 95% recycled material.

1. 3/16" BYNA-LOK® WIRE TIE (STANDARD)
2. 9 GA. OR 3/16" CONTINUOUS WIRE
3. 3/16" BOX BYNA-TIE (STANDARD)
4. SEISMICLIP®
5. LOOP-LOK™ WASHER (OPTIONAL)

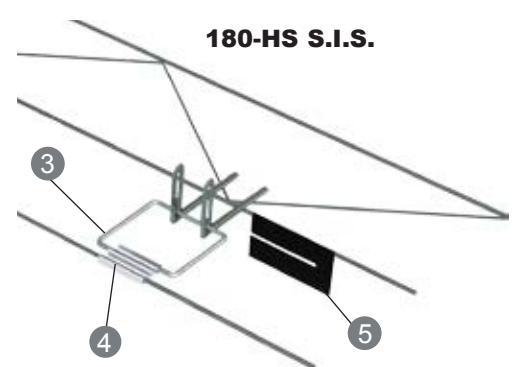
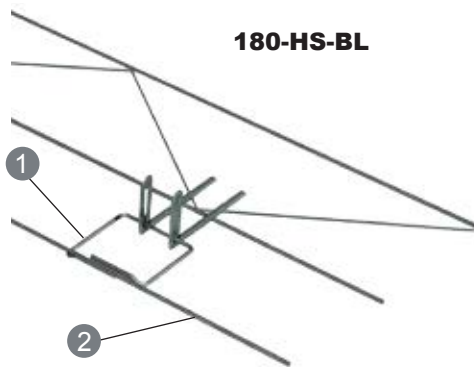

SYSTEMS FOR HIGH WIND LOADS AND CAVITY CONDITIONS UP TO 7 1/2"

MIGHTY-LOK® ●

Mighty-Lok® adjustable joint reinforcement has been redesigned to feature the **NEW! Mighty-Lok® Hook**. The 1/4" diameter hook still features a flattened and serrated pintle but now has compressed vertical legs for increased adjustability up to 2-1/4". This allows for optimum performance in today's multi-wythe construction with extra-wide cavity walls or when mortar joints are not in close alignment. This is the only 1/4" Ø system that meets the ACI-530 code by allowing for a 3/8" mortar bed.

Features:

Modified eyelets and pintles afford usage where high strength requirements are present and standard eyelets and pintles would fail (including extra-wide cavity conditions and high wind loads). Also designed for usage where standard eyelets and pintles would fail due to greater than normal misalignment of mortar joints between the 2 wythes.

Modified eyelets engage pintles in conformance with existing codes (less than 1/16" mechanical play).

Pintles are flattened and serrated for superior bonding with mortar and offer 2-1/4" of vertical adjustability.

Available Truss style (**170-ML**)
or Ladder style (**270-ML**).

U.S. Patent No.
6,668,505; 8,122,663;
& 8,613,175
Other Patents Pending

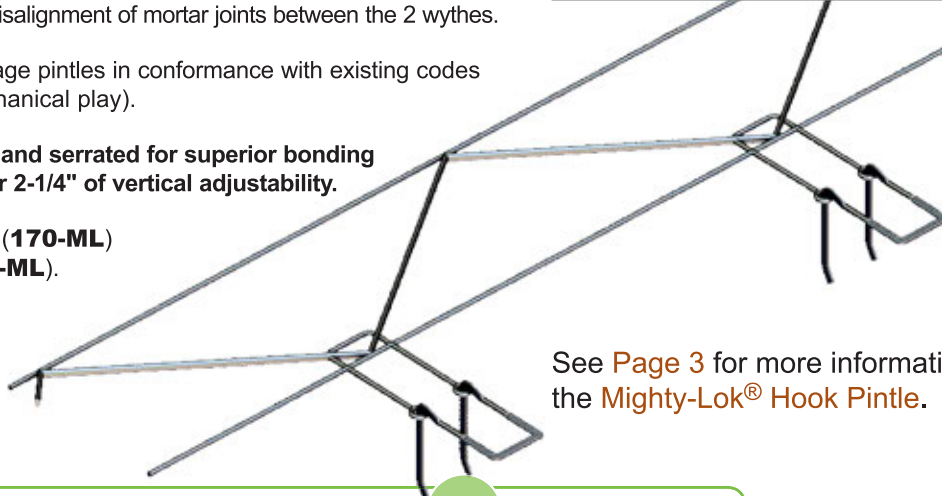
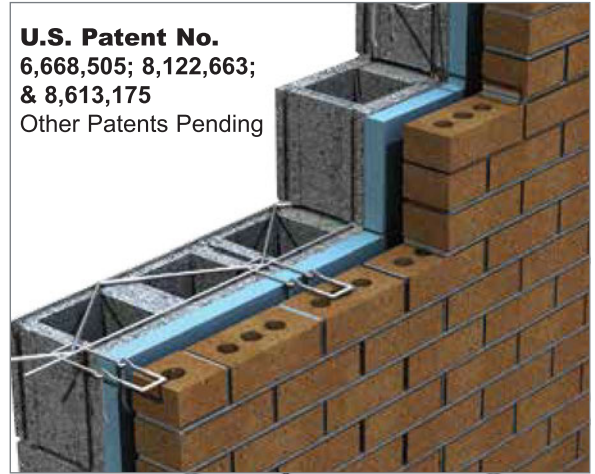

See [Page 3](#) for more information about the **Mighty-Lok® Hook Pintle**.

H&B manufactures steel wire products from a minimum of **95%** recycled material.

HB-213-HS High-Strength Veneer Anchor System

Now available for heavy-duty applications, our new HB-213-HS High-Strength Veneer Anchor System incorporates the **NEW Mighty-Lok® Hook**. The Mighty-Lok® Hook is flattened and then serrated for superior bonding with mortar while maintaining a 3/8" mortar joint per Code ACI-530 section 6.2.



Ideal for usage when the offset of engagement between pintle and anchor is greater than 1-1/4" (limit set by standard ACI-530). Standard leg length will accommodate up to 2-1/4" offset while maintaining sufficient strength. Longer leg lengths are available on special order, subject to loading requirements. (**NOTE:** TMS 402-13/ACI 530-13/ASCE 5-13 indicates maximum offset of 1-1/4" for standard 3/16" diameter pintle.)

Also ideal for wide cavity conditions, where a standard 3/16" pintle would not satisfy lateral load requirements. (Note: TMS 402-13/ACI 530-13/ASCE 5-13 indicates maximum allowable span of 4-1/2" for standard 3/16" diameter pintles.)

U.S. Patent: 8,122,663 & 8,613,175 Backplate available 12 ga., 11 ga., or 10 ga.
Other Patents Pending



ADJUSTABLE ANCHOR SYSTEMS FOR RUBBLE STONE

Tie-2R Anchor System ●

For Filled Cavity/Solid Collar Joint Conditions

This anchor system for rubble stone walls with masonry backup allows the mason to place anchors where they are needed. The joint reinforcement has 9 ga. deformed side rods, a 3/16" dia. cross rod and a 1/4" dia. heavy duty outer rod projecting into the cavity. To this rod the stone mason attaches HELICAL HOOK ANCHORS with an easy twist.

Anchor Type HS is for horizontal joints and Type HP for vertical joints. Thus, the mason can fit the ties to the wall rather than having to build the wall to fit the ties. **Must be used with a filled solid collar joint.**

Finishes: Hot Dipped Galvanized or Stainless Steel.



Tie-HVR-190V Anchor System ●

In this system, the backup is reinforced with truss type reinforcement. The mason then places the vertical rod into the collar joint by hooking onto the extended truss cross rod. Rubble stone can then be tied easily to the backup using modified Vee Byna-Ties®. Horizontal mortar joints do not have to align.

U.S. Patent No. 8,375,667. Other Patents Pending.

H&B manufactures steel wire products from a minimum of 95% recycled material.

Tie-HVR-195V Anchor System ●

Tie-HVR-195V is for use with cavity or insulated walls. The modified Vee Byna-Tie® accepts a vertical J-Hook, preventing in-and-out movement of the masonry tie and allowing maximum vertical adjustability. Installing the ties is much easier as they can be placed wherever the horizontal mortar joint lies without reconfiguring the stone materials.

Available for any wall size. State block, insulation, cavity and rubble stone sizes when ordering. Ladder style also available (Product Tie-HVR-295V).

U.S. Patent No. 8,375,667. Other Patents Pending.

Tie-HVR-195VB Anchor System ●

Tie-HVR-195VB is ideal for use on concrete, CMU, metal stud or when masonry backup is already in place and a new veneer is being installed. The L-shaped plate is sized for any thickness of insulation, and has a slotted hole to accept the vertical J-Hook. Uses the same modified Vee Byna-Tie® as 190V anchor above. State insulation, cavity and rubble stone sizes when ordering.

U.S. Patent No. 8,904,725. Other Patents Pending.

TIE-HVR SERIES size availability:

(S) Standard: 9 ga. side rods x 9 ga. cross rods.

(EH) Extra Heavy: 3/16" side rods x 9 ga. cross rods.

(SHD) Super Heavy Duty: 3/16" side rods x 3/16" cross rods.

Projecting box portion (195V or 295V) available 9 ga. or 3/16" dia.

Finishes: Hot Dipped Galvanized or Stainless Steel (Type 304 or 316).

2X-HOOK VENEER ANCHOR SYSTEMS

HB-213

For Stud Backup

HB-213 SERIES ANCHORS

now feature the new 2X-HOOK to provide over 100% more strength (see page 2-3 for details) than the original HB-213 anchors! HB-213 is an adjustable veneer anchor to accommodate various wallboard and insulation combinations up to 6" thick while providing up to a 200lb. working load in compression and tension resistance.

Features:

- L-shaped plate with ribs for added strength and 9/32" holes to accept various screws.
- Slot allows for pintle insertion and are sized to prevent in-and-out movement beyond allowable tolerances.
- Pintle accepts Seismicclip® and continuous wire for use in Seismic Zones.

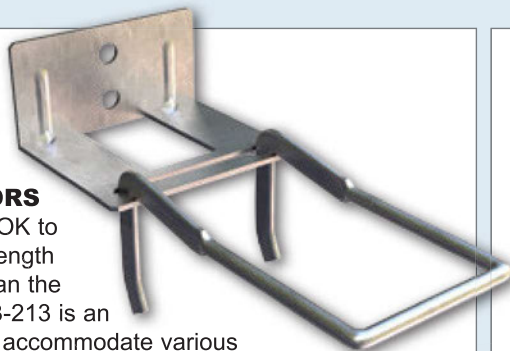

Back Plate: 14 ga. or 12. ga thick

Pintle: 3", 4", 5", 6" or 7" long.
Fabricated to accommodate various wallboard/insulation combinations. Specify thickness when ordering.

Finishes: Hot Dipped Galvanized or Stainless Steel (Type 304 or 316)

U.S. Patent: 8,613,175
Other Patents Pending.

NOTE: Also available with Seismic Hook and Continuous Wire.
See Pg. 7 for more information.

HB-5213

For Masonry Backup

THE HB-5213 ANCHOR features the HB-213 back plate with a single 7/16" diameter hole to accept the BL-523 brass expansion bolt for use in masonry. The HB-5213 will accept insulation thickness' up to 6" without crushing or puncturing the materials and the pintle is available in lengths from 3" to 7" long to allow for various cavity/veneer setups.

THE BL-523 BRASS EXPANSION BOLT

provides a high strength connection in brick, block, concrete, terra-cotta, and other masonry backup systems. The stainless steel internal bolt is surrounded by a brass expansion sleeve that is torque activated providing an easy method of inspection.

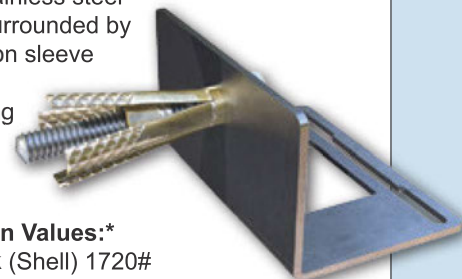

Ultimate Tension Values:*

C-90 CMU Block (Shell) 1720#
C-90 CMU Block (Rib) 2015#
Brick Masonry 1550#
Brick/CMU Mortar Joint 1435#
Concrete (3000psi.) 1785#

*Loads are ultimate capacity, reduce values by 4 or more to determine allowable working loads.

See page 2-3 for more information about the 2X-Hook.

HB-200-X

The HB-200-X creates a positive connection between the back plate and metal studs. It features three pronged punch-outs that project from the back of the anchor, transferring positive wind-loads to the stud and preventing these loads from crushing the wallboard.

Available to accommodate 0"- 6" insulation thickness. Pintle portion available in lengths of 3", 4", 5", 6" or 7".

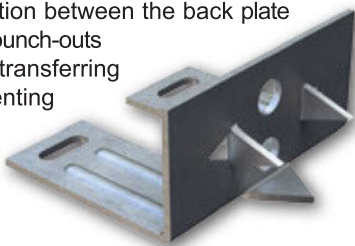

Finishes: Hot Dipped Galvanized or Type 304 or 316 Stainless Steel.

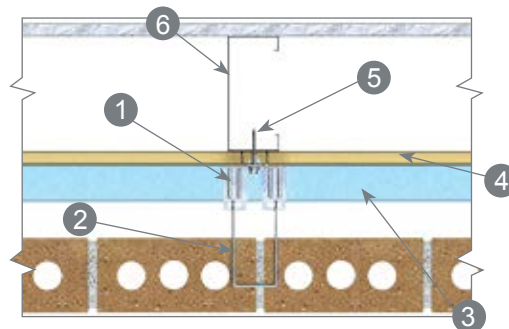

- | | |
|-------------------------------------|--------------------------------------|
| 1. HB-200-X PLATE | 4. GYPSUM SHEATHING |
| 2. 2X-HOOK | 5. H&B SELF-DRILL/
SELF-TAP SCREW |
| 3. RIGID MINERAL WOOL
INSULATION | 6. STEEL STUD |

SELF-SEALING VENEER ANCHORS

X-SEAL® ANCHOR

The X-SEAL® Anchor features a patented pronged leg design that seals the sheathing from air and moisture while maintaining integrity of the air/vapor barrier. The pronged legs bridge the sheathing and abut the steel stud, affording independent, positive anchorage. Compression of the sheathing by positive loads is also prevented. The pronged legs are rib-stiffened and oriented closer to each other, enhancing the compressive strength by over 20%. **Owners, architects and masons can be confident in over 3 decades of proven strength and performance.**

Features:

- Capable of withstanding 100# working loads in tension & compression without deforming or developing play in excess of 0.05".
- Provides 100% protection against separation of wire tie from anchor (See Code TMS 402-13/ACI 530-13/ASCE 5-13).
- Pronged legs seal sheathing from air & moisture infiltration while maintaining integrity of the air/vapor barrier.
- Installed before the veneer allowing for easy on-site inspection.
- Secures Insulation to the backup better than staples or screws.



Dimensions: Available in leg lengths from 1/2" - 4-1/2" to accommodate wallboard and/or insulation

Finishes: Hot Dipped Galvanized or Stainless Steel Type 304

U.S. Patents: 6,925,768; 6,941,717; 7,587,874; 7,845,137 & 7,562,506

Canadian Patents: 2,458,008 & 2,458,012

Other Patents Pending.

NOTE: For added security against moisture infiltration, Hohmann & Barnard recommends using a **continuous strip of X-SEAL TAPE** over the insulation before installing the X-SEAL Anchor.



Anchors on pages 12-13 meet or exceed requirements of the **Commonwealth of Massachusetts State Building Code** for air leakage and water penetration. Contact H&B's technical department for test results.

2-SEAL™ TIE

An innovative single-screw veneer tie for metal stud construction. Fabricated from Zamac zinc with a premium quality organic polymer coating, the 2-Seal™ Tie has a **dual-diameter barrel with factory-installed EPDM washers to seal both the face of the insulation and the air / vapor barrier.** This is an improvement over single barrel types which only seal at the insulation and render the vapor barrier susceptible to air and moisture infiltration if not precisely installed (perfectly perpendicular to the stud).

The dual-barrel has an integrated #12 self-drilling screw, and is available for insulation/wallboard (sheathing) sizes from 5/8" - 4" thick. The projecting eyelet accepts the **2-Seal™ Byna-Lok Wire Tie.**

Barrel portion available in 5/8", 1", 1-1/2", 2", 2-1/2", 3", 3-1/2", 4" and 4-1/2" lengths to accommodate insulation/wallboard (sheathing). The polymer coated barrel allows stainless steel or hot dipped galvanized wire ties to be used; preventing a galvanic reaction from dissimilar metals.

For wood or concrete masonry applications please use Concrete 2-Seal™ Tie.
For steel stud with wood or gypsum sheathing, use Standard 2-Seal™ Tie.

U.S. Patent: 8,037,653

CAN. Patent: 2,690,819

Other Patents Pending.

Installation chuck adapter sold separately.

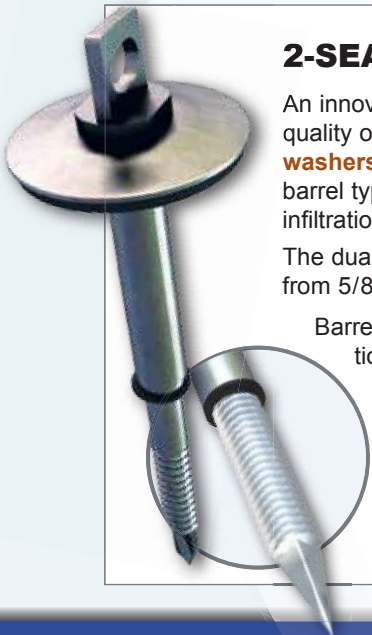

FIRE-RESISTANT THERMAL ANCHORS

THERMAL 2-SEAL™ TIE

Heat transfer through the wall cavity is a major source of lost energy — and ultimately dollars spent on heating and cooling. Hohmann & Barnard has engineered an innovative new anchor to solve this problem. The Thermal 2-Seal™ Tie features a dual-diameter Stainless Steel barrel to seal at both the insulation and the air barrier while reducing thermal transfer through the cavity to as little as one-seventh the conductivity of standard zinc barrels.

FEATURES

- A large diameter washer secures insulation to the back up while a **second smaller washer completely seals the air barrier for a continuous membrane.**
- Stainless Steel Barrel **reduces thermal conductivity by as much as ONE-SEVENTH** of a standard zinc barrel and **ONE-THIRD** compared to carbon steel barrels.
- A proprietary UL-94 coating creates a thermal break at the insulation.
- Uses a 2-Seal Byna-Lok Wire Tie for easy addition of a continuous wire.
- Barrel available in lengths of 5/8", 1", 1-1/2", 2", 2-1/2", 3", 3-1/2", 4" and 4-1/2" lengths to accommodate insulation. **Other sizes available upon request.**



**U.S. Patent:
8,037,653**
Other Patents Pending

H&B's Stainless Steel barrels have one-third the thermal conductivity of carbon steel barrels and one-seventh the thermal conductivity of our competitors' zinc barrels.

Metal Type	Thermal Conductivity (W/cm K)
AISI-SAE 1020 (Plain Carbon Steel)	0.52
Stainless Steel (Type 304)	0.15
Zinc Alloy (Galvanizing)	1.1

Please visit www.h-b.com for more information on Hohmann & Barnard material specifications.

AVAILABLE ANCHORS:

Standard Thermal 2-Seal™:

for use in steel stud with wood or gypsum sheathing.

Concrete Thermal 2-Seal™:

for concrete, wood, or masonry backup.

**U.S. Patent:
7,415,803; 8,613,175;
D702,544 & D706,127**
Other Patents Pending

THERMAL 2-SEAL™ WING NUT

The thermal 2-Seal™ Wing Nut Anchor is an innovative single screw veneer tie for metal stud construction that features a Stainless Steel Barrel with two washers **to seal at both the insulation and the air barrier** just like the Thermal 2-Seal anchor above **with the following added features:**

- A UL-94 coating encapsulates a steel wing, creating a thermal break at the insulation.
- **Wing is reinforced by a steel core to MAINTAIN INTEGRITY OF THE ANCHORING SYSTEM IN CASE OF FIRE** making it superior to clip-on plastic wings that **will melt if exposed to extreme heat.**
- Pre-installed wings reduce labor by up to 50% compared to clip-on wings that must be installed on the job site.
- Wing accepts a standard, seismic or Mighty-Lok® Pintle and spins to easily orient pintles/hooks with masonry joints.
- Wing is adjustable up to 1/2" to accommodate various insulation thickness' and secure insulation to the backup.

Polymer-coated Stainless Steel barrel has an integrated 5/16" hex head for easy installation and is available in lengths of 5/8", 1", 1-1/2", 2", 2-1/2", 3", 3-1/2", 4" and 4-1/2" to accommodate insulation. **Other sizes available upon request.**

STEEL REINFORCED ANCHORS WILL NOT FAIL like typical clip-on plastic only wings!

Contact our technical department for full test results

COLUMN AND BEAM ANCHORS

NEWLY DESIGNED COLUMN AND BEAM ANCHORS increase pull out strength.

Contact Hohmann & Barnard's technical department for testing information.

Column & beam anchors are **99%** recycled material.

#353 ● Column Anchor



#353 - 1-1/4" wide x 12 ga. thick. Made to order based on flange width and overall length. Other thicknesses (including 1/4" heavy duty) available upon request.

For anchoring masonry to structural column when masonry is perpendicular to column flange and there is no space between the CMU and the column.

U.S. PAT. #8,904,731. Other Patents Pending.

#353L ● Column Anchor with lok-bolt

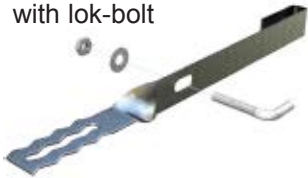

#353L - Same as above. Made with a slotted hole to accept Positive Lok Bolt to mechanically engage both sides of the flange.

For anchoring masonry to the building frame while restraining both positive and negative wind load actions when there is a space between the CMU and the column.

U.S. PAT. #8,904,731. Other Patents Pending.

#354 Notched Column Anchor ●



#354 - 1-1/2" wide x 12 ga. thick. Notch is 1" wide, beginning 1" from end. Made to order in any length. Other notch sizes available on special order.

For anchoring masonry to structural column when masonry is parallel to column flange. Can be used in wall with or without air space.

U.S. PAT. #8,904,731. Other Patents Pending.

#355L ● Column Anchor with lok-rod



#355L - 1-1/4" wide x 12 ga. thick. Other thicknesses (including 1/4" heavy duty) available upon request. Made with a slotted hole to accept Positive Lok Rod.

For anchoring masonry to the building frame while restraining both positive and negative wind load actions.

U.S. PAT. #8,904,731. Other Patents Pending.

#351 & 352 ● Wire Column Tie



#351 - 3", 5", 7" or 9" long. For use with masonry that is parallel to column flange.

#352 - 8", 10", 12" or 14" long. For use with masonry that is perpendicular to column flange.

Dimensions: 3/16" or 1/4" diameter with 2" Bend and 2-1/2" Hook with 1/2" opening.

Finishes: Hot Dipped Galvanized or Stainless Steel (Type 304 or 316).

H&B manufactures steel wire products from a minimum of **95%** recycled material.

WELD-ON TIES AND ANCHORING SYSTEMS

#359 & #359-C Weld-On Ties ●



#359FP & #359FP-C Weld-On Ties ●



#359FH Weld-On Ties



Weld-On Ties - Used in conjunction with Vee-Byna® Tie (page 18) or Column Web Ties (see below). Anchors masonry to structural steel frame while allowing vertical differential movements between steel and masonry.

Finishes: Hot Dipped Galvanized or Stainless Steel (Type 304 or 316).

Note: 359FP & 359FP-C have exaggerated offset (**specify dimension when ordering**) to allow for spray-on fireproofing. Optional backplate (sold separately) restrains compressive loads.

#301W & 302W Column Web Tie ●



#301W - 3/16" or 1/4" diameter x 12" long. For use with #359 Weld-On Tie (anchoring masonry to structural column).

#302W - Same availability as above with a 1" flat end for use with #359FH Weld-On Tie.

Widths: 2-3/8", 4", 6", 8", 10", 12" to accommodate various size CMU.

Finishes: Hot Dipped Galvanized or Stainless Steel (Type 304 or 316).

H&B manufactures steel wire products from a minimum of **95%** recycled material.

BL-407 Anchor

BL-407 is a wire tie and plate combination system that provides adjustability, strength, stiffness, positive connection, corrosion resistance, and is test rated.

Features:

- Provides for in-plane differential movement.
- Provides vertical movement of up to 1-1/4".
- Addition of Wedge-Lok® fastener secures insulation in place.
- Can be paired with Vee Byna-Tie® and Seismiclip for use in seismic zones.

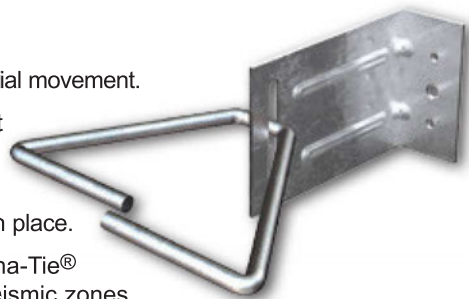

Base Plate: 16 ga. thick X 2" wide with 1" bend. Length to accommodate various insulation thicknesses.

Vee Byna-Tie: 3/16" or 1/4" diameter X 3", 4", 5", 6", 7" or 9" long.

Finishes: Hot Dipped Galvanized or Stainless Steel (Type 304 or 316).

Note: Combine with BL-523 Expansion Bolt for a high strength restoration anchor.

Self-Drilling Self-Tapping Screws

Self-Drilling Self-Tapping Screws are for use with various anchors including Brick Ties, Gripstay Channels, X-Seal® & HB-213 series veneer anchors. Screws feature a Hex Washer Head (HWH) for easy installation.

STANDARD SCREW

- #10 x 1-1/2" with or without washer.
- #12 x 1-1/2", 2", 3", 4" with washer.
- #14 x 5" with washer.

Finishes: Polymer Coated or Type 410 Stainless Steel.



TYPE 304 STAINLESS STEEL SCREW

Type 304 Stainless Steel shaft provides maximum corrosion resistance while a carbon steel point allows for easy installation through metal studs.

Available Sizes:

- #12 x 2", 3", or 4" with washer.
- #14 x 5" with washer.

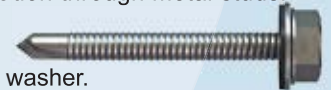

SEISMIC VENEER ANCHORS

#303 SV Seismic-Notch Dovetail Anchor



#345 SV Seismic-Notch Veneer Anchor



#364 SV Seismic-Notch Gripstay Anchor



HB-213S

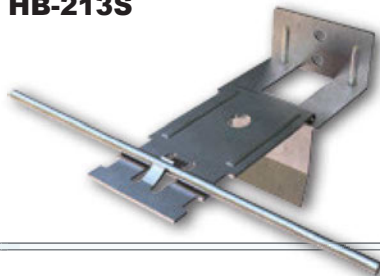

H&B Gripstay, Dovetail and L-Shaped Anchors can be modified to comply with seismic codes, which call for continuous wire in the veneer to be an integral component of the anchor system. **The end of these anchors are corrugated, creating a "Seismic Notch"** to accommodate 9 gauge or 3/16" diameter continuous wire.

#303 SV - 1-1/4" wide x 14 ga. or 12 ga. thick with a standard dovetail head. **Use with the #305 dovetail slot (pg. 19).** Made to order in any length.

#345 SV - Same availability as above with bent end and 9/32" diameter hole to accommodate hardware. Made to order in any length.

#364 SV - Same availability as above with a standard gripstay notch. Made to order in any length.

HB-213S - Formerly known as the T-LOK TIE™, available 14 ga. or 12 ga. thick. Backplate portion made to accommodate insulation up to 6" thick. Pintle portion available in 3-1/2" or 4-1/2" long in 12ga. or 11ga. material. **Other sizes available upon request.**

Configuration of the HB-213S Seismic Plate Pintle allows easy insertion into slot, while preventing future disengagement. This also prevents tie from being installed beyond allowable eccentricity.

Finishes: Hot Dipped Galvanized or Stainless Steel (Type 304 or 316).

The Channel-Tee Seismic-Notch Anchor System

Ideal for use where maximum vertical adjustability is preferred. The Continuous Channel is surface mounted to the back up. The Seismic-Notch Anchor is then easily inserted into the channel anywhere along the vertical length to conveniently fit wherever the mortar joint lies. Continuous joint reinforcing wire is easily inserted into the seismic notches of each anchor.

- Thin 5/8" profile of channel is ideal for tight cavity conditions. Channel provided in 10' lengths.
- Holes drilled 12" on center in channel.
- Seismic-Notch Anchor available 14 ga. thick by 3", 3-1/2", 4", 4-1/2" or 5" long.
- Other sizes available upon request.
- All components available Hot Dipped Galvanized or Stainless Steel (Type 304 or 316).

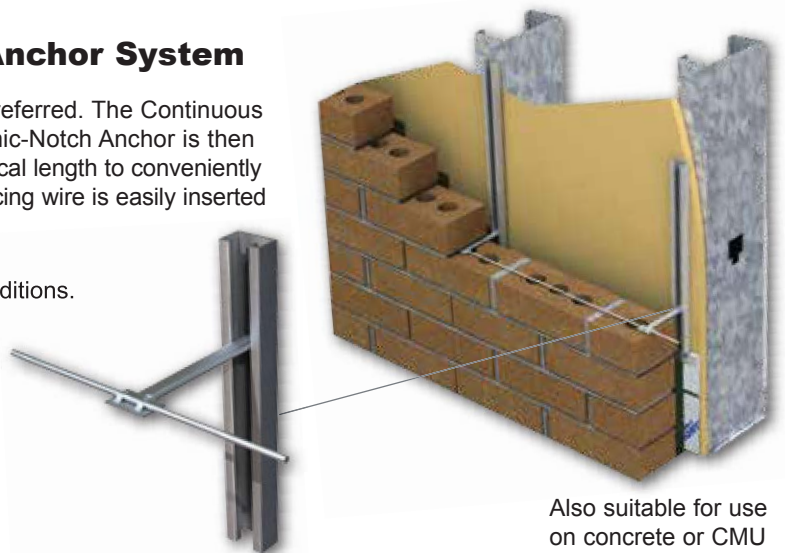

Also suitable for use on concrete or CMU

GRIPSTAY™ CHANNELS & ANCHORS

#362-CX - Gripstay™ Channel Slot

The 362-CX GRIPSTAY™ CHANNEL features factory-welded prongs to bridge the insulation and abut the concrete block (or other substrate), affording independent, positive anchorage. The integrity of the insulation is maintained while compression due to positive loads is transferred to face of CMU.

Available: 14 ga., 12 ga., or 11 ga. thick with a standard length of 5' 0". Other lengths are available in 7-1/2" increments (example: 15", 22-1/2", 30").

Finishes: Hot Dipped Galvanized or Stainless Steel (Type 304 or 316).



U.S. Patents: 5,063,722
Other Patents Pending.



Standard Gripstay Channels



#360 - welded

#361 - embedded

#362 - surface mounted

#360 - 7-1/2" long (5-1/2" vertical adjustability).

#361 - Furnished with built-in straps for embedment into block back-up.

#362 - 6-1/4" long o.a., furnished with integrally-formed tabs for attachment to masonry.

#362-C - 5' long continuous channel, other lengths available in 7-1/2" increments (15", 22-1/2", 30" etc.).

Standard:

14 ga., 12 ga. or 11 ga. thick with 5/16" holes.

Finishes:

Hot Dipped Galvanized or Stainless Steel.

U.S. Patents: 5,063,722

Other Patents Pending.



#362-C with optional Lok-Channel Clip

#363 Flexible Gripstay Anchor



363-BL ●
Byna-Lok®
Flexible Gripstay

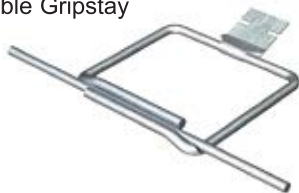

#365 Bent Gripstay Anchor



Gripstay Head fits any style H&B Gripstay Channel above for tying masonry to steel columns, concrete, or existing walls.

#363 - Gripstay head is 14 ga. thick x 1-1/4" wide. Vee Byna-Tie® portion is 3/16" or 1/4" dia. x 3", 4", 5", 6" 7" or 9" long. Other sizes available upon request. (shown far left)

#363-VBT - Same as above with the addition of Seismiclip® for use with Continuous Wire in seismic zones. (Shown in 363 Gripstay wall diagram, above).

#363-BL - Gripstay head is 14 ga. thick x 1-1/4" wide. Byna-Lok® portion is 3/16" dia. x 3", 4" or 5" long. Other sizes available upon request.

#365 Standard - 1-1/4" wide X 16, 14, or 12ga. thick. Bend is 1" long. Longer bends available upon request.

Finishes: Hot Dipped Galvanized or Stainless Steel (Type 304 or 316).

NOTE: Gripstay anchors can be modified to fit larger Unistrut channels.

H&B manufactures steel wire products from a minimum of **95%** recycled material.

WALL TIES AND ANCHORS

Byna-Lok® Tie ●



Byna-Lok® Wire Tie

Standard - 3/16" diameter X 3", 4" or 5" long

For use with various H&B anchors including the X-Seal® Anchor, the Byna-Lok Tie features swaged and pitched legs for easy installation of continuous wire while maintaining a standard 3/8" mortar joint.

Finishes: Hot Dipped Galvanized or Stainless Steel.

VBT - Vee Byna-Tie® ●



VBT - Vee Byna-Tie® Standard - 3/16" or 1/4" diameter X 3", 4", 5", 6", 7" or 9" long. Other sizes available upon request.

For use with H&B's DW-10 Series Anchors, X-Seal® Anchors (tying brick veneer to steel studs), or #359 Series Weld-On Ties (tying masonry walls to steel columns).

Finishes: Hot Dipped Galvanized or Stainless Steel.

Wire manufactured from a minimum of 95% recycled material.

Seismiclip Interlock System



Seismiclip® Interlock System (S.I.S.) For use with H&B wire ties and Continuous Wire. Components snap into the Seismiclip allowing them to function integrally as a single unit. Conforms to International Building Code for seismic zones.

Available Sizes:

#187 - For use with 3/16" diameter ties.

#250 - For use with 1/4" diameter ties.

Both versions accept 9 ga. and 3/16" continuous wire.

Finishes: Impact-resistant, rigid P.V.C. with retaining ridges to securely snap in wire ties and continuous wire.

DW-10HS® w/ Vee Byna-Tie®



DW-10HS® W/ Vee Byna-Tie® - 14 ga. or 12 ga thick X 5-1/2" long with over 3" of vertical adjustability. Features the Vee Byna-Tie (see above) to anchor brick veneer to steel stud.

For anchoring brick veneer to metal stud, masonry, concrete or wood backup. Primarily for use when there is no insulation and little potential for wallboard deterioration.*

DW-10HS® S.I.S. - Same as above with the addition of Seismiclip® for use with Continuous Wire in seismic zones. (shown in DW-10HS wall diagram on left)

DW-10HS® w/ Byna-Lok®



DW-10HS® W/ Byna-Lok® Tie - Same dimensions as above with Byna-Lok® Tie instead of Vee Byna-Tie®

Byna-Lok® Tie (see top of page) allows for easy installation of Continuous Wire without the use of Seismiclip®.

Finishes: Hot Dipped Galvanized or Stainless Steel.

*NOTE: For insulated walls, or when there is concern about wallboard deterioration please see our X-SEAL® Anchor (page 12).

WALL TIES AND ANCHORS

315 Flexible ● Dovetail Brick Tie



#315 Permits horizontal and vertical movement of the masonry wall while restraining tension and compression. Can be surface mounted or used with **#305 Dovetail Slot** (below).

Available Sizes:

Dovetail Head - 14 ga or 12 ga thick X 1" wide.
Vee Wall Tie - 3/16" or 1/4" diameter X 3", 3-1/2", 4", 4-1/2", or 5" long. Other lengths available upon request.

Finishes: Hot Dipped Galvanized or Stainless Steel
(Type 304 or 316).

315-BT Flexible ● Dovetail Brick Tie



#315-BT Same anchor as above with S.I.S. Seismiclip Interlock System® for use in seismic zones.

Finishes: Hot Dipped Galvanized or Stainless Steel
(Type 304 or 316).

315-BL Byna-Lok® ● Flexible Dovetail

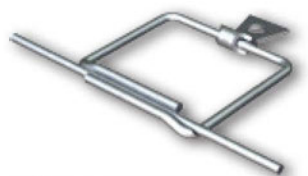

#315-BL Same anchor as above with Byna-Lok® Tie to accept Continuous Wire.

Finishes: Hot Dipped Galvanized or Stainless Steel
(Type 304 or 316).

#305 Dovetail Slot Standard - 1" wide back x 1" deep x 22 ga., 18 ga. or 16 ga. thick by 10' long foam filled. 24 ga. also available in Stainless Steel only.

Finishes: Hot Dipped Galvanized or Stainless Steel
(Type 304 or 316).

IMPORTANT: We are not responsible for incompatibility if ties or slots are interchanged with those of other manufacturers.

H&B manufactures steel wire products from a minimum of 95% recycled material.

345-BT ● Flexible Tie



#345-BT For tying masonry to concrete or CMU backup with a flexible (not rigid) connection. It is comprised of a Vee Byna-Tie® with wrap-around metal strap to allow for installation with Seismiclip® and Continuous Wire.

Available Sizes:

Wrap-around strap - 12 ga thick X 3/4" wide with 5/16" hole
Vee Byna-Tie - 3/16" or 1/4" diameter X 3", 3-1/2", 4", 4-1/2", or 5" long. Other lengths available upon request.

Finishes: Hot Dipped Galvanized or Stainless Steel
(Type 304 or 316).

345-BL Byna-Lok® ● Flexible Tie



#345-BL Byna-Lok® Tie fitted with same strap as above. Swaged and pitched Byna-Lok allows for addition of the continuous wire without need for the seismiclip.

Finishes: Hot Dipped Galvanized or Stainless Steel
(Type 304 or 316).

MISCELLANEOUS ANCHORS & ACCESSORIES

Slip-Set Stabilizer

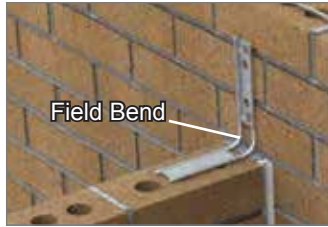
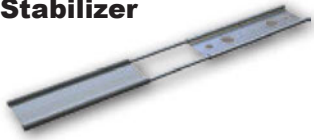

Slip-Set Stabilizer - Bonds masonry walls and restrains lateral movement while allowing expansion and control joints to perform as designed. Field bend to connect intersecting walls, or new walls to existing walls.

Finishes: Mill Galvanized, Hot Dipped Galvanized or Type 304 Stainless Steel with a loose PVC "Slip-Tube"

#344 Rigid Partition Anchor



#344 - For anchoring load bearing walls at an intersection. Fabricated from 1/4" bar stock 1-1/2" wide per code ACI-530. Length is custom to job with 2" standard bends on each end.

Finishes: Hot Dipped Galvanized or Stainless Steel (Type 304 or 316).

CWT Corrugated Wall Tie



Manufactured from **99%** post industrial recycled material.

CWT - Standard - 22 ga., 18 ga., or 16 ga. thick x 7/8" wide x 7" long. Other sizes available upon request.

Finishes: Hot Dipped Galvanized or Stainless Steel Type 304.

CCJ Corrugated Control Joint

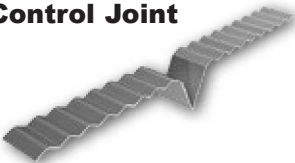

CCJ - Standard - 22 ga. thick X 7/8" wide X 7" overall length. V-Section is 1-3/4" deep.

Corrugated Control Joint Anchors allow the wall to expand and contract preventing concrete from cracking.

Finishes: Hot Dipped Galvanized or Stainless Steel.

Glass Block Panel Anchor



Glass Block Panel Anchor - Standard - 20 ga. thick x 1-3/4" wide x 24" or 16" long. Designed to anchor glass block to the adjacent structure.

Finishes: Hot-Dip Galvanized or Type 304 Stainless Steel.

MWT Mesh Wall Tie

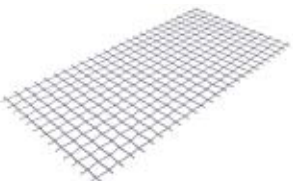

MWT - For bonding intersecting masonry walls. Conforms to ASTM A740.

Dimensions: 1/2" square by 16 ga. 3", 4", 6", 8", or 10" wide by 100' roll. Other sizes available upon request.

Finishes: Hot Dipped Galvanized (ASTM A 153) or Type 304 or Type 316 Stainless Steel (ASTM E 437).

MGS Mortar / Grout Screen



MGS - Monofilament screen is fabricated from high strength, non-corrosive polypropylene polymers. Isolates flow of grout in designated areas requiring reinforced concrete block. Also allows for greater bonding of masonry anchor in hollow block construction.

Dimensions: 1/4" square x 4", 6", 8", 10" or 12" wide x 100' rolls.

REBAR & SCAFFOLDING ACCESSORIES

Spyra-Lox® Rebar Lap-Joint Tie ●

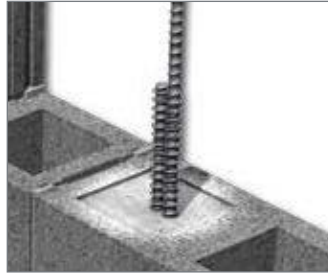

Spyra-Lox®

SL 4/5 - #4 or #5 rebars.
SL 6/7 - #6 or #7 rebars.
SL 8/9 - #8 or #9 rebars (#9 is 1-1/8" o.d. nominal, 1.27" actual).
SL 11 - #11 rebars (1-1/4" o.d. nominal, 1.41" actual).

No tools. Eliminates cumbersome procedure of tying lap-joined rebars together in reinforced walls. Increases worker productivity. Reduces lifting-height of block over rebars. Flow-through design allows grout to uniformly encase rebars at overlap.

Finish: Mill Galvanized

Wire manufactured from a minimum of recycled material. **95%**

RB & RB-Twin ● Rebar Positioners

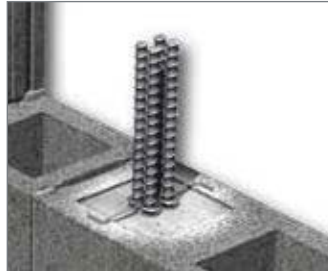

RB - 9 ga. dia. wire for 6", 8", 10" or 12" block.

For positioning rebars in center of block. The z-shaped wire bridges cell of block while bends rest on shell.

RB-Twin - Same as above with double loops to hold 4 rebars.

Finishes: Mill Galvanized
Hot Dipped Galvanized
Stainless Steel (Type 304 or 316)

OSHA and Mushroom Caps



OSHA Caps - 4X4 high-impact plastic and durable texture provides extensive protection on construction work zones. This product meets Federal OSHA Standards.

Standard: Size 3-7
Medium: Size 8-12
Large: Size 12 & Up

Mushroom Caps - Used as a protective cover for bolts, pipes, rebar and other protrusions that could be potentially hazardous. This product is not intended to eliminate impalement or accidental falls, but to reduce possible risks or dangers.

Standard: Fits a variety of diameters from 1/2" to 2-1/4".

SCAFFOLD CLIPS

Scaffold Clips are used to secure poly or safety fence to scaffolding easily and quickly. Manufactured from a flexible plastic that will not become rigid or snap in extreme conditions.

Available - 6" or 11" long, 100 pieces per box.



PTA SERIES PARTITION TOP ANCHORS

PTA SERIES PARTITION TOP ANCHORS have been developed to provide lateral shear resistance at the upper limit of masonry walls. They permit vertical deflection of the slab above while resisting positive and negative lateral shear loads, without transferring compressive loads to the masonry wall below. PTA Series Anchors are suitable for construction using steel or concrete. PTA Tube with expansion filler is placed over rod anchor, which has been attached to concrete or steel by any of the methods illustrated. The vertical joint is then filled with mortar, fully surrounding tube. **Other sizes available for heavy-duty applications. Contact 1-800-645-0616 for more info.**

PTA-310



PTA-310-HS



PTA-310 - #3 rebar rod with 3/16" thick Dovetail Head.

PTA-310-HS - Standard - 5/8" rod with 1/4" thick Dovetail Head.

For use on concrete construction. Must be used in conjunction with H&B #305 Dovetail Slot and PTA Tubes.

U.S. Patent 8,978,326 Other Patents Pending.

Finishes: Hot Dipped Galvanized or Stainless Steel.

PTA-420-HS



PTA-420-HS - Standard - #3 rebar with 3/16" thick plate containing 5/16" diameter holes.

For use on concrete or steel beam construction. Use with PTA Tubes.

Finishes: Hot Dipped Galvanized or Stainless Steel (Type 304 or 316).

PTA-422

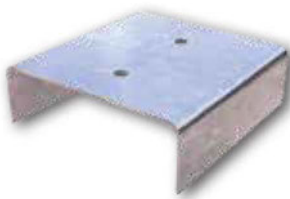

PTA-422 - Standard - 12 gauge thick with 2" standard bends. Widths to fit 4"-12" block. Use on concrete or steel construction. Provided with two 7/16" holes for mounting hardware.

Finishes: Mill Galvanized, Hot Dipped Galvanized or Stainless Steel (Type 304 or 316).

HB-LSA-1



HB-LSA-2



LSA - Standard - 12 gauge thick with 2-1/2" standard bends. Widths to fit 4"-12" block.

Use as a Lateral Support Anchor for concrete or steel beam where the slab and wall are offset.

Finishes: Hot Dipped Galvanized or Stainless Steel (Type 304 or 316).

Note: LSA Anchors comply with CSA A370-14.

PTA TUBES - Grey plastic Tubes filled with compressible polyethylene filler. **For use with PTA-310, 310-HS and 420-HS anchors**



CONCRETE INSERTS



LW-340 & HW-340 Malleable Iron Wedge Inserts



Wedge inserts are embedded into concrete slabs. Nail holes in the back of the insert allow easy nailing to forms. When the forms are stripped, the open face of the insert is flush with the concrete. The beveled head of the askew head bolt engages the internal wedge shape of the insert and produces an automatic tightening action when a shear or dead load is placed on it.

Available Hot Dipped Galvanized.

Note: LW-340 Long Wedge Insert is suitable for use at the bottom of the slab or when additional vertical adjustability is needed. HW-340 Standard Wedge Insert must be installed at least 1-1/2" from bottom of slab. **Both anchors require a minimum of 1-1/2" of concrete above the top of the insert.**

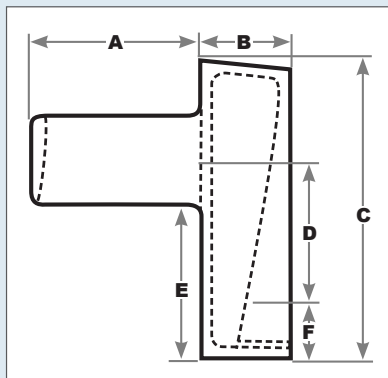

	LW-340	HW-340
BOLT DIA.	3/4"	3/4"
A	2-3/8"	2-1/2"
B	1-3/16"	1-3/16"
C	5-1/2"	4"
D	3"	1-3/4"
E	3-1/2"	2"
F	7/8"	7/8"

Performance Data				
	Shear	Tension	Concrete Strength	Torque
LW-340	17,305 lbs.	17,367 lbs.	4,125 psi	150 ft./lbs.
HW-340	16,650 lbs.	13,093 lbs.	4,125 psi	150 ft./lbs.

All values listed are ultimate capacities in pounds which should be reduced by a minimum safety factor of three to determine the allowable working loads.

Askew Head Bolt for Wedge Inserts

3/4" dia. x 2", 2-1/2", 3" or 4" long;
Other Lengths available upon request.

Available Hot Dipped Galvanized or Stainless Steel
(Type 304 or 316).

CARBON STEEL	60,000 psi minimum tensile strength
STAINLESS STEEL	70,000 psi minimum tensile strength

Horseshoe Shim for Wedge Inserts

3" or 4" tall by 1/8", 1/4", or 3/8" thick.
Other sizes available upon request.

Finishes: Mill Galvanized, Hot Dipped Galvanized and Stainless Steel (Type 304 or 316).

SHARKTOOTH AND CSH INSERTS

Hohmann & Barnard's SHARKTOOTH INSERT has various applications and is capable of developing working loads up to 8,000#/ft. in both shear and tension. It is adjustable along virtually its entire length, and also allows in and out adjustment, while still resisting shear and tension loads. Available in hot dipped galvanized or Type 304 Stainless Steel (Type 316 available on special order). It is fabricated in lengths from 3" to 12'-0" long, and can be custom designed for project-specific applications, such as radii or specific lengths. The Sharktooth Insert is a new, labor-saving, pre-engineered, high-strength insert from H&B.

Features:

- Serrated shark-tooth design allows insert to resist high vertical shear loads (eliminates potential for vertical slip due to inadequate bolt torque, as with wedge style inserts).
- Rebar interference not an issue (unlike post-installed expansion bolts).
- Additional rebar hairpins not required to develop published working loads.
- Allows for substantial vertical adjustment along full length of insert.
- Welded connections not required. Nut or bolt connection into insert allows for easy installation and adjustment.
- Bolting hardware is U.S. standard thread (metric thread can be difficult to source).
- Custom design available for special load requirements.

CSH INSERTS meet the demand for a high strength continuous slotted insert.

Various Applications



ST-4 Brick relief angle at concrete beam.



CSH-R Cast into radial concrete to accept handrails.



ST-12 Insert is cast into concrete walls to accept stone anchors.



CSH-4 Cast into the underside of the concrete slab to accept pipes, ductwork, mechanical equipment, etc.

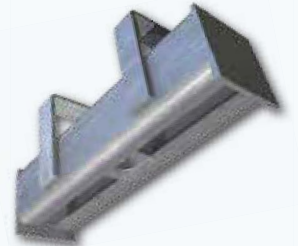

Working Loads: Single Point Loading

Insert Length*	Spacing Between Studs	Allowable Loads		Ultimate Loads	
		Tension	Shear	Tension	Shear
3"	n/a	5300#	5185#	10,600#	10,370#
4"	n/a	5300#	5185#	10,600#	10,370#
6"	4"	7889#	8059#	13,432#	20,147#
8"	5"	7889#	8059#	13,432#	20,147#
12"	5"	7889#	8059#	13,432#	20,147#
24"	5"	7889#	8059#	13,432#	20,147#
12'-0"	6"	7889#	8059#	13,432#	20,147#

*Other lengths available on special order.

Working Loads: Multiple Point Loading

Insert Length	Minimum Spacing Between Load	Allowable Loads	
		Tension	Shear
12"	5"	4525#	8059#
24"	5"	4525#	8059#
12'-0"	6"	5300#	8059#

Sharktooth Insert Patent# D724769

Other Patents Pending

CONCEALED LINTEL SYSTEMS FOR BRICKWORK

Hohmann & Barnard's Concealed Lintel Systems are individually designed and engineered to fit even the most intricate and complex architectural requirements.

Architects can feel free to incorporate this distinctive feature into prestigious edifices for projects such as Places of Worship, Libraries, Schools, University Buildings, or wherever the design calls for stately and enduring elegance.

Features:

- Every concealed lintel system is custom designed and engineered to meet the unique architectural and structural requirements of individual projects.
- Hohmann & Barnard provides all necessary drawings, calculations, and components.
- The opportunities for **Architectural Creativity** are virtually limitless.
- Designers can incorporate various masonry courses, spans, offsets and soffit widths.
- Freedom to select various sizes and colors of brickwork.
- No further maintenance is required – all steel is unexposed when finished.
- Designed, Engineered and Fabricated in the **USA!**

Finishes: Hot Dipped Galvanized or
Stainless Steel (Type 304 or 316).

Material Conformance

Carbon Steel	Hot Dipped Galvanized	Stainless Steel (Type 304 or 316)
ASTM A36 / A36M	ASTM A123 / A123M ASTM A153/A153M-B2	ASTM A276 ASTM 240 ASTM A666

Flat Spine

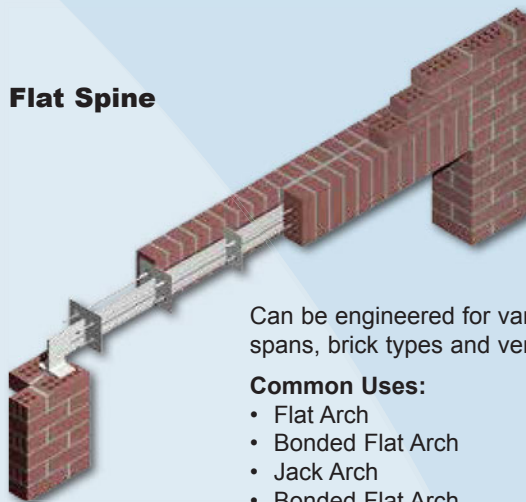

Can be engineered for various widths, spans, brick types and veneer loads.

Common Uses:

- Flat Arch
- Bonded Flat Arch
- Jack Arch
- Bonded Flat Arch

Arched Spine

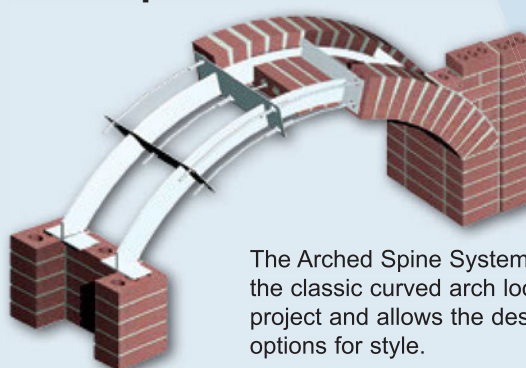

The Arched Spine System provides the classic curved arch look for any project and allows the designer many options for style.

Common Uses:

- Semi-Circular Arch
- Bonded Semi-Circular Arch
- Paladin Style Arch
- Gothic Arch

Surface Mounted Arch

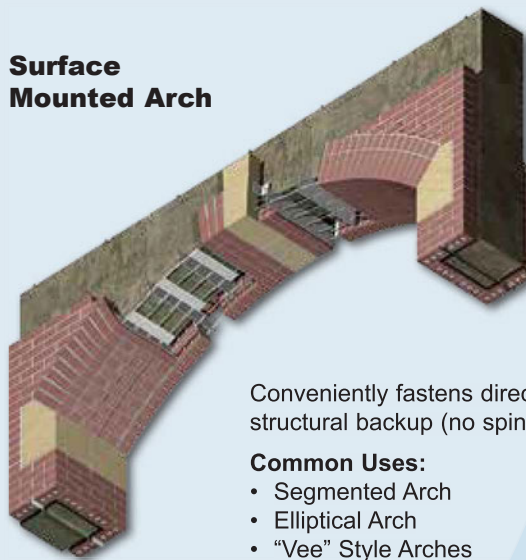

Conveniently fastens directly to the structural backup (no spine required).

Common Uses:

- Segmented Arch
- Elliptical Arch
- "Vee" Style Arches

CUSTOM METAL FABRICATION SERVICES

THROUGH MANY YEARS OF LEADING THE INDUSTRY in anchoring & reinforcement products for masonry; H&B has developed metal fabrication capabilities, skill, and equipment that are second to none.

- **Cutting:** State-of-the-art facilities capable of consistently and precisely cutting stainless steel, aluminum, copper, brass, titanium or mild steel into virtually any shape or component you need.
- **Fabrication:** From bending to welding, H&B can manufacture your designs to exact specifications every time for a trouble-free assembly.
- **Design:** Our team of designers will collaborate with you to conceptualize, visualize, and design cost effective solutions that meet your demands.
- **Prototyping:** If you have an idea, but need help conceptualizing the final product, our experts will create a prototype for approval before production begins.
- **Rush Delivery:** H&B dedicates a portion of their schedule to timely delivery of rush projects so we can deliver fast and accurate products every day.



**This is only a small sampling of H&B's capabilities.
For more information call: 800.645.0616**

STONE ANCHORS AND ACCESSORIES

HOHMANN & BARNARD can fabricate custom stone anchors from mild steel up to 1" thick Stainless Steel. H&B has over 80 years of fabrication expertise with jobs spanning the 50 United States, Canada, and world wide.

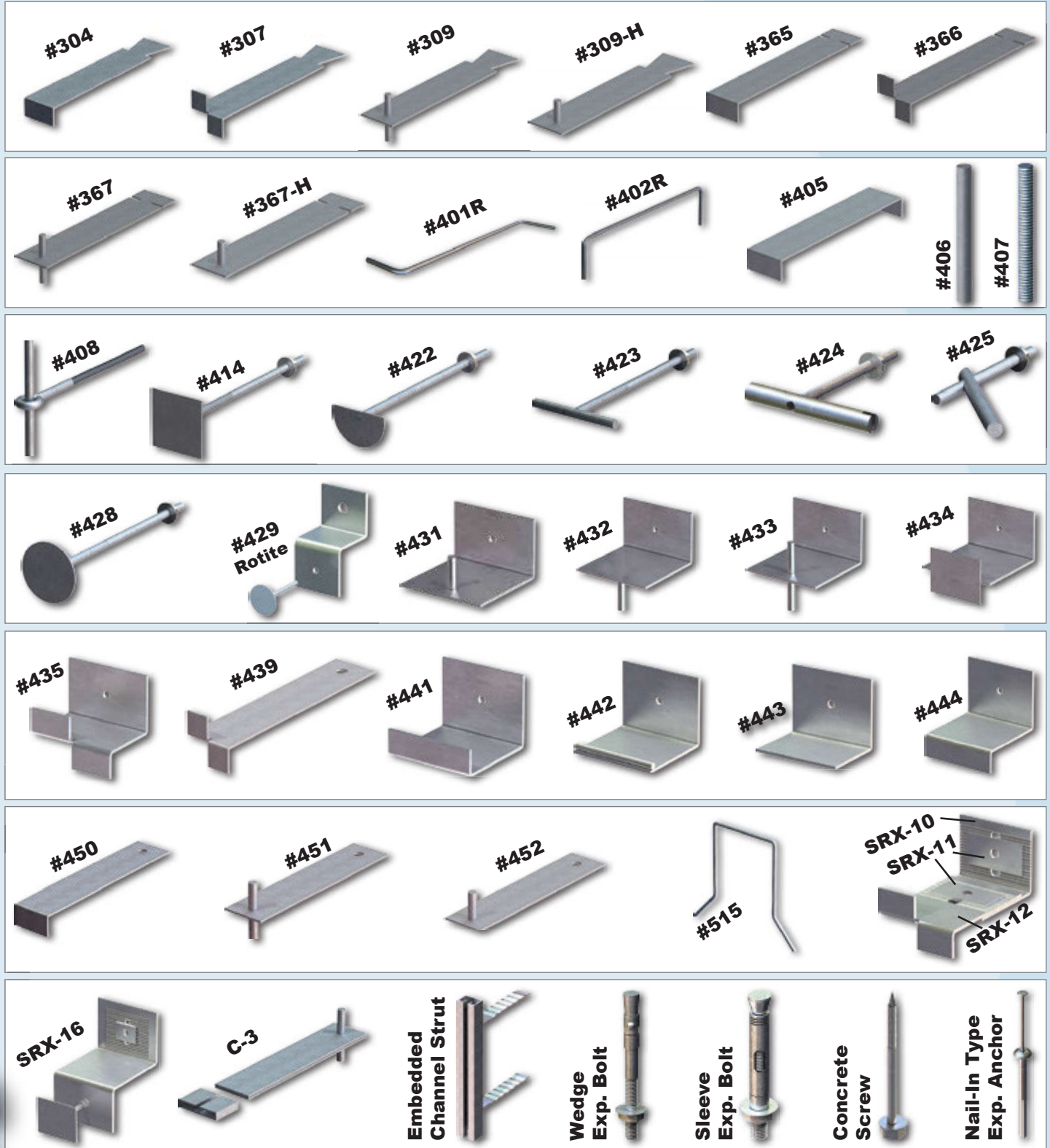

Manufactured from an average of **60%** recycled material.

TORQ-LOK® MECHANICAL RESTORATION SYSTEM

The Torq-Lok® mechanical anchoring system is an easy to use and cost-effective method to re-connect existing veneers to various substrates. Anchors are manufactured of AISI Type 300 series austenitic stainless steel and ASTM Type 360 brass for a corrosion-resistant tie assembly. The 500 and 510 Series system consists of brass expansion elements that are situated in the veneer and backup segments of the wall system being rehabilitated. They are torque-activated which provides a method of inspection for both the façade and backup connection.

Use around bulging areas or sections that are to be removed. Can be used in high stress areas or to replace broken or cracked headers in composite walls.

500 Series Anchor

for Solid Backup

360 Brass expanders with Type 304 Stainless Steel shaft and 300 Stainless Steel hardware.

Hole in Veneer = 1/2" Hole in Backup = 1/2"

Installation Torque:

Veneer = 30-80 in.- lbs. Backup = 30-80 in.- lbs.



510 Series Anchor

for Hollow Backup

360 Brass expanders with Type 304 Stainless Steel shaft and 300 Stainless Steel hardware.

Hole in Veneer = 1/2" Hole in Backup = 3/8"

Installation Torque:

Veneer = 30-80 in.- lbs. Backup = 30-80 in.- lbs.



520 Series

for Stud Backup

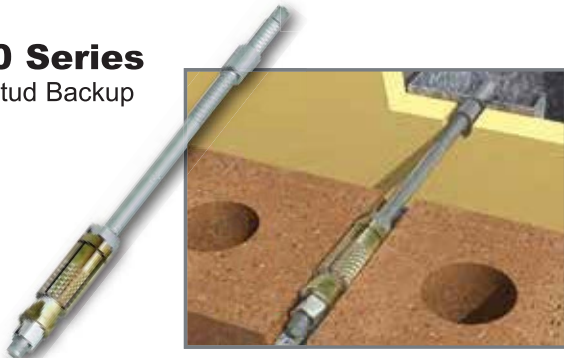

360 Brass expanders with Type 304 Stainless Steel shaft and 300 Stainless Steel hardware. Self-drilling / self-tapping screw.

Hole in Veneer = 1/2"

Hole in Backup = self-drilled

Installation Torque:

Metal Stud = 25-50 in.-lb.
(30-80 in.-lb. for 16 ga.)
Structural Steel = 30-80 in.-lb.

530 Series

for Stud Backup



360 Brass expanders with Type 304 Stainless Steel shaft and 300 Stainless Steel hardware. Self-tapping lag thread.

Hole in Veneer = 1/2"

Hole in Backup = 3/16"

Installation Torque:

Veneer = 30-80 in.-lb.
16 ga = 30-60 in.-lb.
18 ga = 20-40 in.-lb.
Wood Stud = 30-50 in.-lb.

Torq-Lok® Selection Chart

(based on a typical 3-5/8" veneer)

	Hollow CMU	Solid CMU	Concrete	Brick	Clay Tile	Wood	Metal Stud	Steel
500 SERIES		●	●	●	●			
510 SERIES	●	●	●	●	●			●
520 SERIES							●	●
530 SERIES						●	●	

Torq-Lok® Shaft Properties

(Ultimate Shaft Buckling Strength)

SHAFT LENGTH (in.)	5-1/2	6-1/2	9-1/2	11-1/2
CAPACITY (lb.)	1620	1425	1100	725

PANEL-LOK® RESTORATION ANCHORS FOR STONE VENEER

The Panel-Lok® re-anchoring system is an easy to use, mechanically-activated, cost-effective method to re-connect existing stone panel veneers to various substrates. Anchors are manufactured of AISI Type 300 series austenitic stainless steel and ASTM Type 360 brass for a corrosion-resistant tie assembly. They are either torque activated or hammer set which provides a method of inspection for the backup connection. Field testing can easily be performed by direct tension or to torque after installation is complete.

The backup anchorage system and the veneer connection method develop performance characteristics similar to the original stone anchoring requirements. The expanders are integrated with a stainless steel shaft and various hex or screw attached heads for the stone veneer connection. They are available in a variety of lengths, and can be custom manufactured upon request.

Basic Applications

Use where there is a need to re-attach existing stone panel veneers less than three inches thick that require additional restraint or support to resist live and dead loads. These Panel-Lok anchors accommodate bilateral live-load resistance, unidirectional forces, support loading, and combinations of all types. The backup anchorage system may dictate the style of anchorage required.

600 Series Anchor

Uni-directional loading to restrain stone panel to solid backup.



600-TGL Series Anchor

Bilateral loading to restrain stone panel to solid backup.

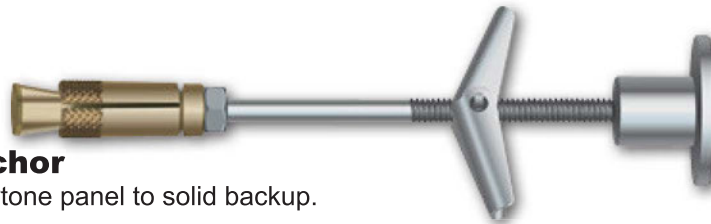

T Series Anchor

Torque activated, support and restrain stone panel to solid backup with or without cavity.



610 Series Anchor

Restrain stone panel to hollow and solid backup.



610-S-TGL Series Anchor

Bilateral loading to restrain soft-stone panel to steel backup.



H Series Anchor

Stabilize stone panel to concrete backup (3/8", 1/2", 3/4" diameter).

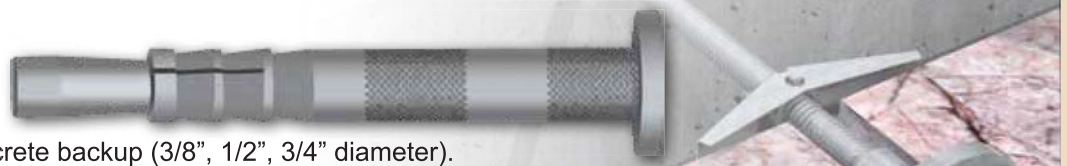

H Series Anchor

Stabilize stone panel to concrete backup (1/4" diameter).



SPIRA-LOK® The Original Helical Wall Tie System

A one-piece, flexible stainless steel wall tie for pinning masonry to new or existing walls. Also suitable for temporary support for lintel and shelf angle replacement. The dry-set technique may involve various tie diameters, drill bits and installation tools.

Available in 8 mm or 10 mm diameter in lengths from 6-1/8" (155 mm) through 24" (600 mm) long in Stainless Steel Type 304. (316 available by special order).

Features

- Only a small diameter pilot hole required.
- No toxic adhesives or expansion devices.
- Site-tested immediately after installation.
- Functional in a wide variety of building materials.
- Able to withstand cyclic loading.
- Accommodates differential movements between materials.
- Does not stress or fracture fragile substrates.

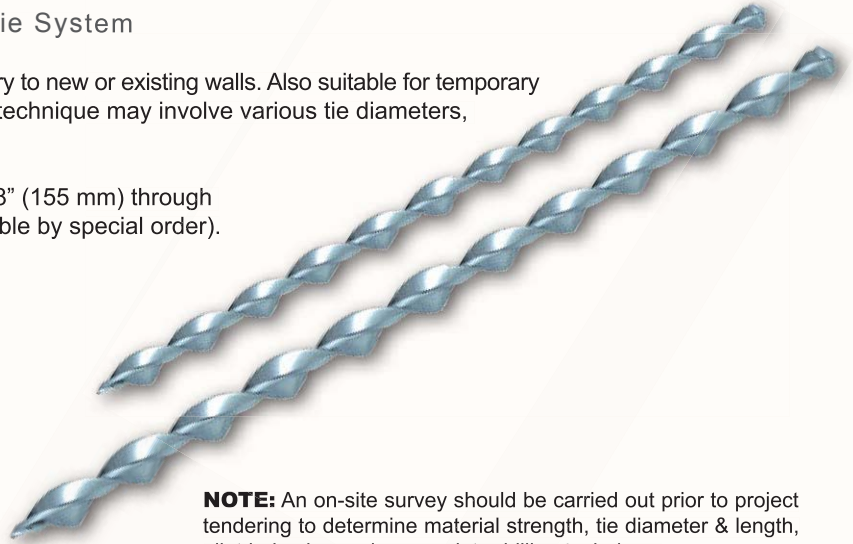

NOTE: An on-site survey should be carried out prior to project tendering to determine material strength, tie diameter & length, pilot hole size and appropriate drilling technique.

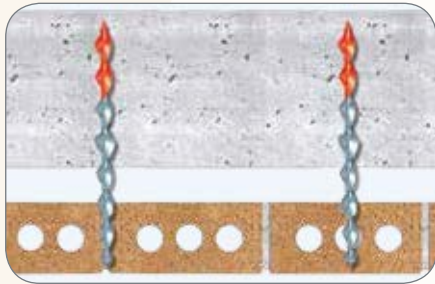

Brick to Concrete
(mortar joint or solid brick - use asymmetrical ties)

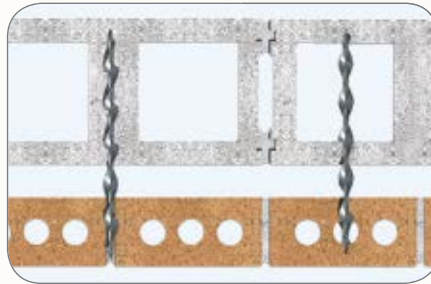

Brick to Concrete Block



Dimensional Stone
to Concrete or Masonry

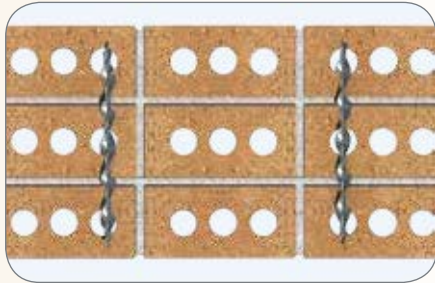

Multi-Wythe Brick

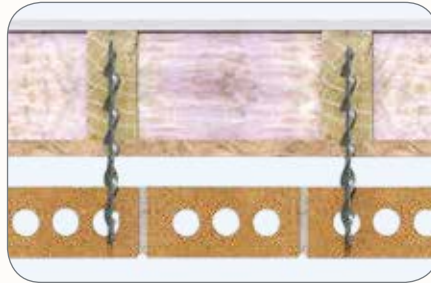

Brick to Wood Stud
(mortar joint or solid brick)

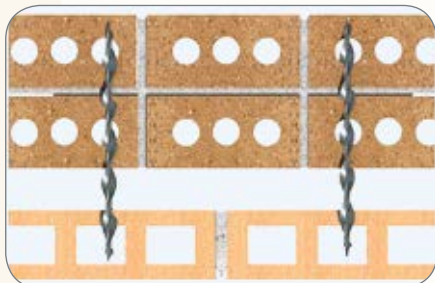

Terra Cotta to Masonry

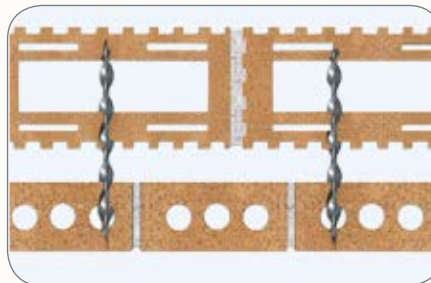

Brick to Clay Tile

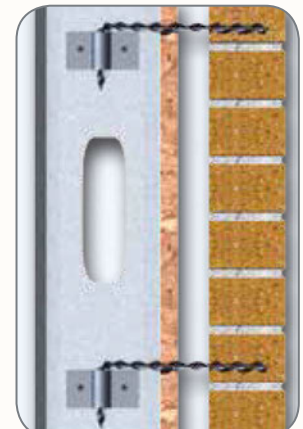

Interior: Steel Stud to Brick

In 2011 **DIEDRICH TECHNOLOGIES** joined the **Hohmann & Barnard Family of Companies** allowing H&B to provide the nations leading Masonry Cleaning and Restoration Detergent products as part of their ever-evolving product line for the masonry industry. Diedrich cleaners, strippers, and water repellent products are accepted for use when restoring buildings on the National Register of Historic Places and provide a safe, cost-effective alternative to damaging processes such as sandblasting and muriatic acids. This section is only a sampling of the Diedrich product line; **please visit www.diedrichtechnologies.com or call 1-800-283-3888 for more information.**

NEW MASONRY CLEANERS

202 New Masonry Detergent

A more productive general purpose New Masonry Detergent with a combination of organic and inorganic acids, wetting agents and inhibitors for professional use in the final clean up of new masonry, 202 efficiently cleans off residual mortar, job site soiling, staining and efflorescence. It will work on brick, stone, tile, exposed aggregate and several varieties of new masonry construction not susceptible to metallic staining. Will not discolor or damage masonry surfaces, and is safer and more controllable than raw muriatic acid.

Typical Coverage Rates:
150 to 200 sq. ft./gal.

Suggested Dilution Rates

1 Part Product:	To:
Concrete and Clay Block	4 parts water
Hard-Burned Pink, Salmon & Tan Brick	6 parts water
Exposed Aggregate Concrete	6 parts water
Structural Tile (Unglazed)	6 parts water
Red Brick	6-8 parts water
Sandstone, Ohio Bluestone, Other Porous Stone	8 parts water (If metallic stains are present prior to testing or appear afterwards, do not use 202 — Use 202V Vana-Stop)
Specialty Pre-Faced Concrete Block & Tile	8 parts water
Smooth Finished Precast & Cast in Place Concrete	10 parts water
Polished Stone (Granite & Marble)	20 parts water (Product could etch stone; testing required)
Structural & Ceramic Glazed Tile & Brick	10-12 parts water
Burnished Masonry	Refer to Diedrich 222 Cleanser for more information
Metallic Stain/Discolorations	If metallic stains are present prior to testing or appear afterwards, do not use 202 — Use 202V Vana-Stop

202V Vana-Stop™ New Masonry

A productive combination of organic and inorganic acids, wetting agents and inhibitors for use in the professional clean up of new masonry, 202V Vana-Stop New Masonry is specifically formulated for cleaning new brick subject to vanadium, manganese, molybdenum and other metallic stains. It efficiently cleans off residual mortar, efflorescence, job site soiling, and staining. It will work on brick, natural stone, tile, exposed aggregate and several varieties of new masonry construction susceptible to metallic staining. Cleaning with this product greatly reduces the likelihood of a staining occurrence, thereby eliminating costly recleaning and stain removal. Will not discolor or damage surfaces, and is safer and more controllable than raw muriatic acid.

Typical Coverage Rates:
150 to 200 sq. ft./gal.

Suggested Dilution Rates

1 Part Product:	To:
Black, White, Grey Tan & Chocolate Faced Brick; Limestone; Unglazed Structural Tile; Precast & Exposed Aggregate	6 parts water
Colored Concrete Masonry Units (CMU)	10-15 parts water
Sandstone, Ohio Bluestone; Other Porous Stone	8 parts water
Glazed Structural & Ceramic Tile; Ceramic Brick	10 parts water
Burnished Masonry	12-15 parts water: Refer to Diedrich 222 Cleanser for more information



BEFORE

AFTER

WATER REPELLENTS

333 Omegaseal Water Repellent

This is a split face block sealer with heavy duty solids that can be applied year-round at 20°F and above. This series of water repellents provides hydrophobic protection to masonry surfaces through the formation of a semi-permeable membrane. Its flexible membrane remains intact through thermal movement of the masonry, rejects water in the solid state and allows for moisture vapor transmission. The unique blend of silicone polymers provides maximum resistance to destruction from ultraviolet light and acid rain.

Product Selection:

333-E 10%	Use for clay and concrete brick, concrete block, highly porous natural stone, L&S stone and other manufactured stone. Covers 75-100 sq. ft./gal.
333-L 20%	Use for extremely porous block (hollow core split faced) with or without integral waterproofing. Covers 50-100 sq. ft./gal. 2 coats required for warranty consideration

VOC COMPLIANT FORMULATIONS AVAILABLE.

ANTI-GRAFFITI SYSTEM



Graffiti is easily removed from the protected surface

The Diedrich Anti-Graffiti System consists of protective and removal components. **The 333 Omegaseal** delivers graffiti protection, creating a membrane that protects against penetration of most common materials used by vandals.

When a protected surface has been attacked, the graffiti can be removed with either **505 Special Coatings Stripper** or **606 Multi-Layer Paint Remover**, assisted by high-pressure water.

505 Special Coatings Stripper is recommended as the first product to use when removing graffiti since multiple removals are possible without re-application of 333. When the areas that have been stripped with 505 show signs of water absorption, reapply the 333 Omegaseal.

606 Multi-Layer Paint Remover should only be used for the most stubborn types of graffiti damage since re-application of 333 will be required after each use.

See page 34 for more information about 505 & 606 paint removal products

Salt-Bloc Chloride Barrier

Diedrich Salt-Bloc is formulated to block the absorption of chloride ions from de-icing salts into concrete, brick and concrete paver sidewalks and driveways. Salt-Bloc is an all-purpose, deeply penetrating siloxane water repellent and chloride barrier for concrete and pavers. The product protects against the intrusion of moisture causing efflorescence, leaching, mildew, atmospheric staining, chemical attack of chloride salts to reduce rebar and wire mesh corrossions, and freeze/thaw spalling. Salt-Bloc is resistant to the detrimental effects of acid rain and carbon buildups. It is ideal for use on horizontal surfaces, and may also be used on retaining walls, bridge pilings and other vertical concrete applications. Salt-Bloc protects against deep-seated stains caused by mud splashes and other waterborne contaminants. It is highly effective in coastal areas in protecting surfaces from airborne salts.

Product should not be diluted

Typical Coverage Rates (per gallon):

Clay Brick/Pavers: 100-150 sq. ft./gal.

Cement Brick Pavers: 100-150 sq. ft./gal.

Pre-cast & Steel Troweled

Smooth Concrete: 125-175 sq. ft./gal.

Exposed Aggregate Smooth Concrete: 100-150 sq. ft./gal.

WATER-BASE VOC COMPLIANT AND SOLVENT-BASE FORMULATIONS AVAILABLE.

MASONRY RESTORATION CLEANERS

101 Masonry Restorer Super Concentrate

Diedrich 101 Masonry Restorer combines acids and a biodegradable detergent into a powerful cleaner for masonry surfaces. This formulated carbon solubilizing cleaner penetrates, dissolves and suspends grime for easy removal by flushing the treated areas with a high pressure stream of water. The chemical cleaner is applied by spray, roller or soft fiber brush. It removes all airborne dirt, atmospheric carbon, rust, mildew, algae, fungus, exhaust residue, industrial pollutants, weathering discoloration, fire and smoke damage, and most other stains from rough and smooth surfaces of brick, sandstone, fieldstone, stucco, swimming pools, clay tiles, asbestos and slate shingles, some limestones, metal and wood. (For Indiana Limestone, use 707X or 808X alkaline cleaners and 707N after-rinse.)

For Professional Contractor Use Only.

Suggested Dilution Rates

1 Part Product	Up to 10 parts water, depending on degree of accumulated dirt and method of application and rinse
----------------	---

Typical Coverage Rates:
150 to 200 sq. ft./gal.

Envirestore 100™

This product is perfect for the environmentally conscious architect and historic preservationist who wants to eliminate harsh acids. It is a citric based gentle restoration cleaner – safer, environmentally friendly, now made more effective and blended slightly stronger to take on a wider variety of surfaces. It depends on the action of citric and phosphoric acid for its results rather than harsh mineral acids, making it a milder product that poses fewer hazards to workers and the environment. Glass safe, the product will not over-clean brick and stone. Formulated for restoring brick, sandstone, unpolished granite, terra cotta and some limestone, this product is ideal for maintenance cleaning of dirt streaks and stains in strip malls, commercial centers, etc.



AFTER

Suggested Dilution Rates

1 Part Product	Up to 3 parts water
----------------	---------------------



BEFORE

Typical Coverage Rates:
150 to 200 sq. ft./gal.

707X Limestone Cleaner Pre-Rinse

This alkaline-based formula was developed specifically for cleaning heavily carbonized, extremely dirty limestone and sandstone surfaces. It is used with high pressure washing equipment, and is most effective on extremely old limestone structures in urban areas where exposure to atmospheric pollutants is high.

Not generally effective for restoration cleaning of brick, marble or granite.

Product should not be diluted

Typical Coverage Rates:
75 to 125 sq. ft./gal.

PAINT REMOVERS & SPECIALTY CLEANERS

505 Special Coatings Stripper

This opaque, non-flammable, water soluble, non-damaging paint remover has a viscous, heavy body designed to cling to vertical surfaces. Its quick action raises the coating in 10 to 20 minutes for easy water wash-off. This thixotropic solvent can be scraped and sponged clean on interiors recommended for stripping paint from wood, as it does not require neutralization and will not raise or discolor wood grain. A special added inhibitor prevents premature dry-out. The product contains no caustic alkali, acid or benzol. A new mega-strength catalyst, "M-PYROL" resin solvent, is added for extra solvency on hard-to-lift complex paint resins such as epoxies, urethanes, rubber-base, elastomerics, enamels, etc.

Product should not be diluted

Typical Coverage Rates:
50 to 100 sq. ft./gal.

606 Multi-Layer Paint Remover

Designed to dissolve and remove oil and lead base paints, latex paints and varnishes from masonry and metal exterior surfaces under normal conditions, Diedrich 606 paint remover is a specially thickened potassium hydroxide solution which is both biodegradable, when neutralized, and soluble in water. The product is applied without dilution. A thick coat of remover may dwell from 1 to 24 hours, depending on the number of layers and the types of paint. On masonry, use Diedrich 101/101G as an after-wash to clean the dirt and residue that may be left after the paint removal. Use 200, 202, or 707N to neutralize wood surfaces.

Product should not be diluted

Typical Coverage Rates:
50 to 100 sq. ft./gal.



BEFORE



AFTER

960 Heavy Duty Concrete Cleaner

This product is formulated for the removal of dirt, rust, retarders and mud stains from rough stucco and pre-cast finishes, concrete with a heavily textured surface and sand-blasted surfaces. This formulation is ideal for the cleaning and etching of older concrete, and can be used to clean exposed aggregate and concrete block. It can also be used as an economical way to correct color and texture irregularities. When used on colored, smooth white or grey concrete, use highly diluted. Also works as a limestone restoration cleaner.

Suggested Dilution Rates

1 Part Product:	To:
Light Exposed Aggregate	6 parts water
Heavy Exposed Aggregate	2 parts water
Form Finished Concrete	6-8 parts water
Concrete Block (weathering or etching)	2 parts water
Concrete Block (removal of mortar stains, etc.)	6 parts water

Typical Coverage Rate:
100 to 150 sq. ft./gal. @ full strength

Coverage rate can be increased with dilution

COMPOSITE FLASHINGS

TEXTROFLASH™



Available Widths:

12", 16", 18", 20", 24", 36", 48",
54", 60" & 72" wide x 75' long rolls.

Other sizes available upon request.

U.S. Pat. No.
7,823,355 & 7,882,673
Other Patents Pending.

This 40-mil thick composite membrane is made with a proprietary adhesive that offers superior adhesion for optimal performance. This adhesive is factory-laminated to rugged, polyethylene sheeting, yielding a flexible membrane that is suitable for application to masonry, concrete, steel, gypsum and wood.

- Provides dual-layered waterproofing protection.
- Resists tearing and slicing.
- UV-resistant for up to 90 days - adhesive backing will not drool when exposed to UV or heat.



1. TEXTROFLASH™ FLASHING

2. T1 OR T2 TERMINATION BAR
required for surface-mount application

3. DRIP PLATE
required for surface-mount
or thru-wall application

NOTE: H&B recommends using stainless steel corners and end dams for optimal waterproofing protection. See Page 42 for more information.

Use Primer-SA™ and HB Sealant (pg 42) for proper installation.

NUFLEX™ PVC FLASHING

Nuflex* Flashing is intended for use as a low-cost, concealed waterproofing membrane on foundation walls and under concrete slabs. The non-reinforced polyvinyl chloride, waterproofed, impermeable sheet will not be deformed when stretched at room temperature, nor will it tear or rip. The material is suitably stabilized to resist exposure without physical deterioration, and is resistant to acids, alkalis and caustics.

Available Sizes:

- 10 mil: 12", 16", 18", 24", 36", 48" & 60" wide X 150' long rolls.
- 20 mil: 12", 16", 18", 24", 36", 48" & 60" wide X 150' long rolls.
- 30 mil: 12", 16", 18", 24", 36", 48" & 60" wide X 150' long rolls.
- 40 mil: 12", 16", 18", 24", 36", & 48" wide X 150' long rolls.
- 56 mil: 12", 16", 18", 24", 36", & 48" wide X 100' long rolls.



***NOTE:** Nuflex™ PVC Flashing is not recommended for commercial use.

FLEX-FLASH® FLASHING



Moisture infiltration can occur at sills, projections, recesses, intersections and mortar joints. The solution begins with proper flashing. **H&B's Flex-Flash®** is a 40-mil thick product formulated with Elvaloy® Kee*. It does not drool and combines the best features of other types of flashing, making it a truly superior product.

- Extremely tough, with excellent impact and tear resistance.
- Flexibility is maintained in all weather environments, even in extreme heat or cold.
- Highly resistant to oils and repels most chemicals.
- Not susceptible to UV degradation.
- Compatible with most silicone and urethane sealants.
- Suitable for thru-wall or surface-mount applications.

Typical "peel-and-stick" flashings have a **black, rubberized-asphalt** component that can "**drool**" or leach out of the building in warm temperatures if not precisely installed, leaving unsightly marks that are difficult to remove. **Flex-Flash®** has a pressure-sensitive, clear adhesive that will not drool when exposed to UV or heat.

Flex-Flash® may be used in thru-wall or surface-mount applications. For surface-mount applications, apply to clean, dry surface. For surfaces where additional adhesion may be required, use **H&B Foam-Tak™** Hi-Performance Spray Adhesive. Termination Bars must also be used. **Flex-Flash®** should be extended beyond the wall face and cut flush with the brick. Optional Drip Plates may be used to effectively guide moisture to the exterior.

For maximum protection against moisture infiltration, specify the complete **Flex-Flash® Flashing System**, comprised of Flex-Flash®, Mortar Trap™, Foam-Tite Seal™ Drip Plates and Termination Bar.



Surface-Mount



Thru-Wall

U.S. Patents: 6,584,746
Other Patents Pending

For a full list of sealants compatible with H&B Flashings
Please Visit www.h-b.com

FLEX-FLASH® Drip Edge

A 45-mil thick product formulated with Elvaloy® Kee*. The durable, factory-formed extruded drip edge is fabricated 3" wide plus 3/8" drip. Compatible for use with any H&B flashing products.

- Available in Ivory, Grey or Brown to match mortar and/or brick. Special colors available upon request.
- Extremely tough, with excellent impact and tear resistance.
- Flexibility is maintained in all weather environments, even in extreme heat or cold.
- Highly resistant to oils and repels most chemicals.
- Compatible with most silicone and urethane sealants (refer to www.h-b.com for full list).
- Not susceptible to UV degradation.

U.S. Patents: D648,865
Other Patents Pending



Available colors:
Ivory, Brown, and Grey

* Elvaloy is a registered trademark of the DuPont Company.

FLASHING SYSTEMS

MIGHTY-FLASH™

Stainless Steel Fabric Flashing

MIGHTY-FLASH™ is a stainless steel fabric flashing, a Class A material consisting of a layer of polymeric fabric with a single sheet of 304 stainless steel bonded to one side. It is an innovative product featuring excellent puncture and tear resistance, designed to last for the life of the wall.

- Flexible and easy to form on the jobsite.
- Fire resistant: **Conforms to ASTM E84, Class A material.**
- Mold resistant: **ASTM D3273 tested.**
- Heat resistant: no degradation in high heat applications.
- UV resistant for up to 120 days.
- Recyclable.
- A cost-effective alternative to traditional copper fabric flashing products.

LIFETIME WARRANTY

AVAILABLE WIDTHS:

12", 16", 18", 24" & 36" x 60' long rolls.

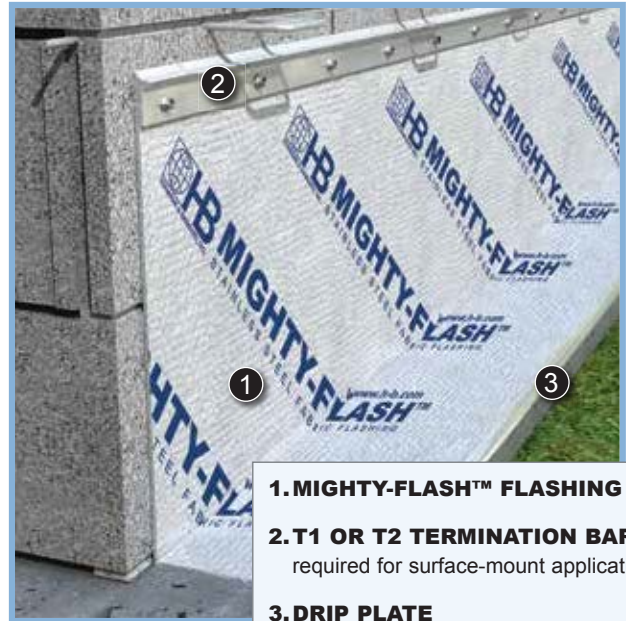

1. MIGHTY-FLASH™ FLASHING

2. T1 OR T2 TERMINATION BAR
required for surface-mount application

3. DRIP PLATE

required for surface-mount
or thru-wall application

See Page 41 - 42 for more information

MIGHTY-FLASH™ SA

Self-Adhering Stainless Steel Fabric Flashing

MIGHTY-FLASH™ SA is a self-adhering stainless steel fabric flashing product with a proprietary clear adhesive. The adhesive is factory-laminated to a Class A material consisting of a layer of polymeric fabric with a single sheet of 304 stainless steel bonded to one side. It is an innovative product featuring excellent puncture and tear resistance, designed to last for the life of the wall. Mighty-Flash™ SA will not degrade under high heat applications and conforms to **ASTM D3273** for mold resistance.



REMOVABLE
RELEASE LINER

- Will not drool from UV or heat exposure.
- Removable Release Liner for easy application.
- Fire resistant: **Conforms to ASTM E84, Class A material.**
- Mold resistant: **ASTM D3273 tested.**
- UV resistant up to 120 days.
- Recyclable.
- A cost-effective alternative to traditional copper fabric flashing products.

LIFETIME WARRANTY

AVAILABLE WIDTHS: 12", 16", 18", 24" & 36" x 60' long rolls.

Manufactured with an average of **60%** recycled content.



NEW! COPPER-FABRIC™ FLASHINGS

These new products combine all of the benefits of Hohmann & Barnard Copper-Tuff™ and Copper-Flex™ flashings with an easy to use color-coded material so you can quickly find the right solution for the job with less inventory.

COPPER COLOR CODE:

3 oz. Copper: GREY

5 oz. Copper: RED

7 oz. Copper: BEIGE

U.S. Patents:
6,928,780 & 6,945,000
Other patents pending

Available in 25 ft. rolls: 12", 16", 18", 20", 24", 32" & 36" wide.
Other sizes available upon request.

COPPER-FABRIC™ NA

A composite membrane consisting of a polyethylene film laminated to BOTH sides of a 3, 5, or 7 oz. copper sheet to create a superior flashing that can also serve as a drip edge.

- Suitable for thru-wall or surface-mount applications.
- UV-resistant for up to 120 days.
- Highly resistant to oils and will repel most chemicals
- Extremely tough, with excellent impact and tear resistance.
- Maintains flexibility in extreme heat or cold weather environments.
- Asphalt-free composition compatible with a wide variety of sealants.

Use with Primer-SA™ & HB Sealant for best results
(see page 42 for more information)

COPPER-FABRIC™ SA

Has all of the same great features of the standard Copper-Fabric NA Flashing with the added benefit of a self-adhesive layer on one side.

- Pressure-sensitive, clear adhesive.
- **Will not drool like other self-adhesive "Peel and Stick" bituminous based flashings.**
- Remains UV-resistant for up to 120 days.



Surface-Mount



Thru-Wall
shown with copper end dam (pg 42.)

NOTE: For optimal performance H&B recommends using Corners and End dams, Termination Bars, & Drip Plates with all flashing products. **See page 41-42 for more information**

COPPER FLASHINGS

C-FAB™ FLASHING



**ASTM B 370
(110 Alloy).**

Hohmann & Barnard C-Fab™ Flashing is a sheet of soft-tempered copper that is permanently coated and bonded between two layers of asphalt-saturated glass fabric. The asphalt-saturated glass fabric adds protection to the copper during shipment, and also adds another layer of waterproofing and chemical resistance. The coarse texture aids in the bonding with mortar.

Available: 3, 5, or 7 oz. copper sheet in rolls 12", 16", 18", 20", 24", 32", & 36" x 25' long. Other sizes available upon request.



Thru-Wall



Surface-Mount

H&B C-Kraft™ Duplex Copper Thru-Wall Flashing



H&B C-Coat™ Copper Thru-Wall Flashing



C-Kraft™ Duplex uses the same sheet copper as C-FAB, but the end product is lighter weight and slightly less expensive, due to the use of kraft paper in lieu of glass fabric. The kraft paper is also asphalt-bonded to the copper on both sides.

Copper sheet used in the fabrication of copper laminates conforms to **ASTM B 370 (110 Alloy)**.

Available in 3, 5 or 7 oz. copper sheet in rolls 12", 16", 18", 20", 24", 32" & 36" Wide x 60' long rolls.

C-Coat™ Flashing combines the flexibility and toughness of copper flashings with the superior waterproofing of an elastic, asphalt compound coating. The sheet copper is shielded from acids, alkalis and electrolysis that may be present in uncured mortar while the asphalt provides a self-sealing, puncture resistant coating.

Available Widths: 12", 16", 18", 24", & 36" x 25' long rolls. Other sizes available upon request.

NOTE: For optimal performance H&B recommends using Corners and End dams, Termination Bars, & Drip Plates with all flashing products. See page 41 - 42 for more information

H&B EPRA-MAX™ EPDM Thru-Wall Flashing



EPDM is a synthetic rubber that has been used for decades in the roofing industry. Its durability under roofing conditions renders it an ideal choice for use in more controlled applications, such as thru-wall flashing. Epra-Max™ remains flexible down to -49° F and is not susceptible to decomposition due to UV exposure. No special contact adhesives are needed when using Epra-Max Adhesive Tape for seams, corners or end dams. For adhesion to various substrates, use the Adhesive Tape in conjunction with Epra-Max Spray Primer, or use H&B's Termination Bars. Optional bonding adhesive is also available. Drip Plates are recommended to guide moisture to the building exterior.

40 mil thick x standard widths of 12", 16", 18", 20", 24" or 36".

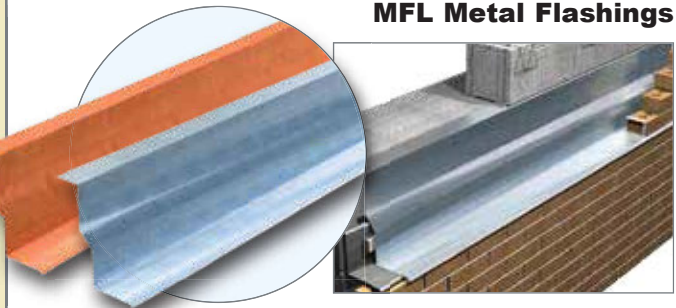
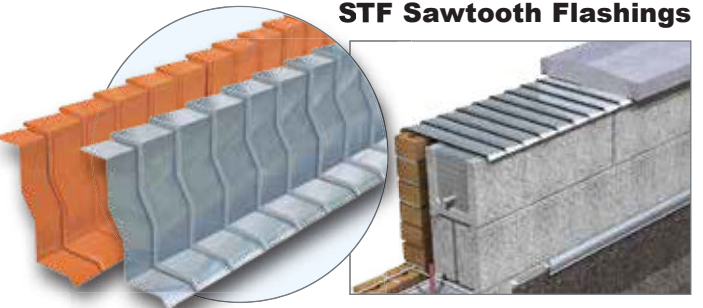

METAL FLASHINGS ●

H&B manufactures a variety of metal flashing products and accessories to suit numerous job conditions. Products include standard sheet flashings bent to custom sizes and shapes, pre-fabricated inside or outside corners, end dams, splice tape and reglets. Seen below are various product styles, each of which are manufactured per the dimensional requirements of the customer. Metal flashing products are manufactured from 26 ga. type 304 or 316 stainless steel and 16 or 12 oz. copper. (Lead-coated copper, terne-coated stainless steel or other gauges are available on special order.)

 <p>MFL Metal Flashings</p> <p>Thru-Wall</p>	 <p>STF Sawtooth Flashings</p> <p>Parapet / Coping</p>
<p>MFL can be formed according to job requirements. State dimensions when ordering. Comes standard with factory-formed, hemmed drip edge.</p>  <p>Surface-Mount</p>	<p>STF acts to bond in all directions. Can be manufactured for parapet/ coping applications, or bent for relief angle applications. State dimensions when ordering.</p>  <p>At Relief Angle</p>

H&B sources Stainless Steel from a wide variety of vendors. Per the International Stainless Steel Forum, Stainless Steel objects have an average of **60%** recycled content.

MFL Outside & Inside Corners

Metal Flashing Outside and Inside Corners are custom-fabricated, pre-formed pieces with a smooth, hemmed drip edge. Outside corners have a continuous, uninterrupted drip edge for a smooth, non-jagged finish (important in maintaining the integrity, aesthetics and safety aspects of the flashing corner).

Compatible with **ST Splice Tape**.

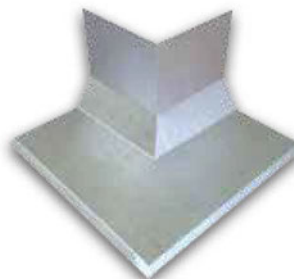

MFL - Outside Corner



MFL - Inside Corner



Outside Corner (Thru-Wall)



Inside Corner (Thru-Wall)



Outside Corner (Surface-Mount)



Inside Corner (Surface-Mount)

DRIP PLATES ●

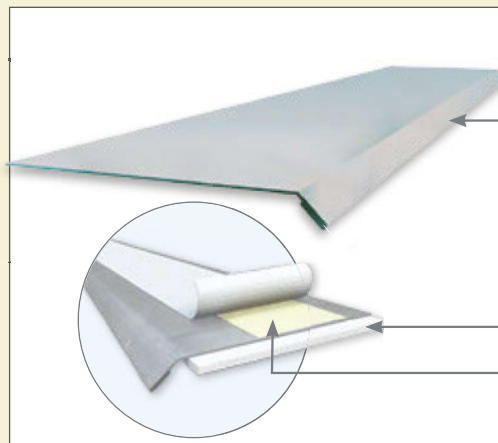

DP Our Standard Drip Plate, furnished with a smooth, factory-formed hemmed edge for installation safety and uniform appearance. Fabricated from Type 304 or Type 316 Stainless Steel. Also available in copper and lead-coated copper. **Standard DP Drip Plates** are compatible with all H&B flashing products.

DP-LB Same as above, for lip brick conditions.

FTS Optional **Foam-Tite Seal™** offers unique added protection against the ingress of water in cavity wall construction. It is a continuous 1/8" strip of factory-installed compressible foam to act as a bond-break and help prevent air and moisture infiltration.

FTS-LB Same as above, for lip brick conditions.

FTSA Adds our optional **Flash-Adhere™ Adhesive Strip*** to the FTS Drip Plate (as described above). This adhesive strip (with tear-off release paper) is factory-installed on the top side of the drip plate to aid in the precise and permanent placement of the flashing.

FTSA-LB Same as above, for lip brick conditions.

Available 1-1/2" or 3" wide by 10 ft. long (other widths available on request).

U.S. Patent: 6,584,746
Other Patents Pending

For corner pieces, reference **"inside"** or **"outside"** with above product numbers.

* Flash-Adhere™ Adhesive Strip is ONLY suitable for use with Flex-Flash® or Copper-Flex™ Flashings.

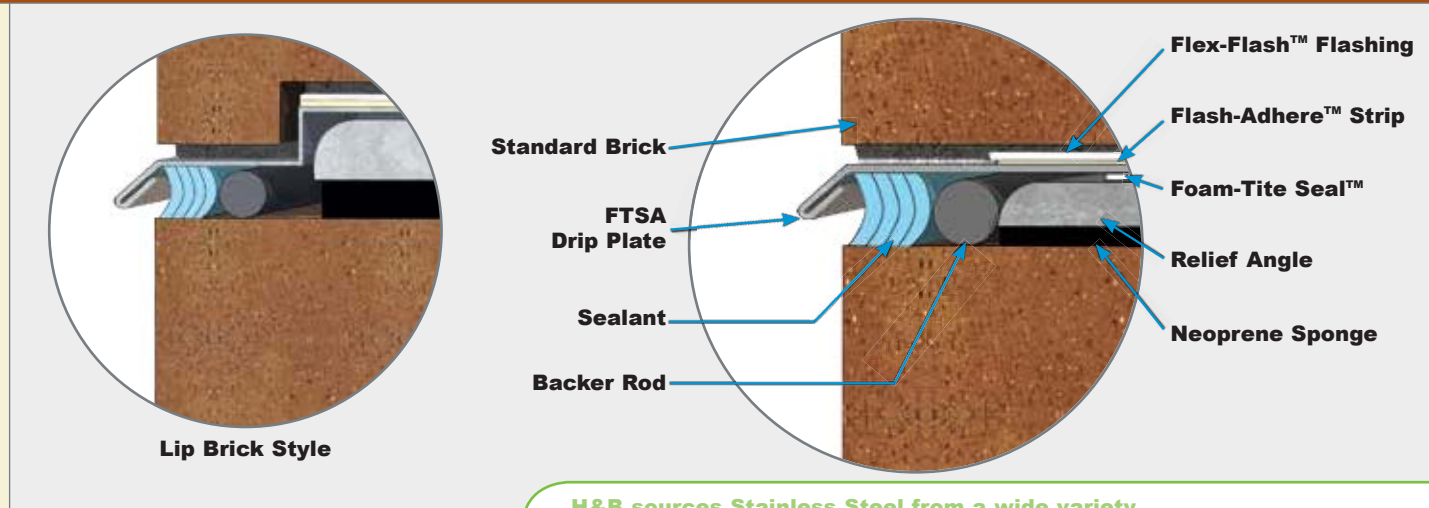

Lip Brick Style

Standard Brick

FTSA Drip Plate

Sealant

Backer Rod

Flex-Flash™ Flashing

Flash-Adhere™ Strip

Foam-Tite Seal™

Relief Angle

Neoprene Sponge

H&B sources Stainless Steel from a wide variety of vendors. Per the International Stainless Steel Forum, Stainless Steel objects have an average of **60%** recycled content.

Drip Plate Corners

Drip Plate Inside and Outside Corners are pre-formed pieces with a smooth, uninterrupted, hemmed drip edge to maintain the integrity of the flashing system. Available with Foam-Tite Seal™ and/or Flash-Adhere™ Adhesive strip*.

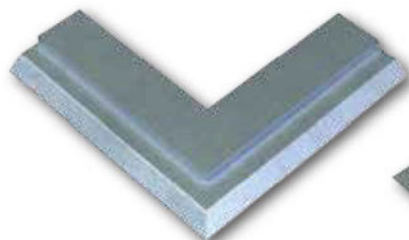

Outside Lip Brick Style

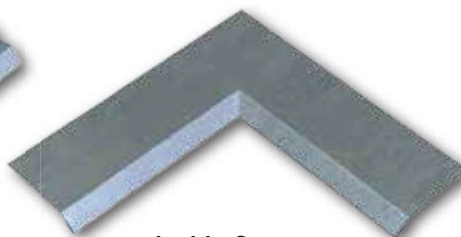

Inside Corner



FLASHING ACCESSORIES

Stainless Steel & Copper Soldered Corners & End Dams

St/Steel - for use with Flex-Flash[®], Textroflash[™], Mighty-Flash[™] and Stainless Steel Metal Flashings.

Copper - for use with Copper-Tuff[™], Copper-Tuff SA[™], Copper-Flex[™] and C-Fab[®] Flashings.

Simply place underneath flashing for the ultimate protection against moisture penetration at corners and end dams.

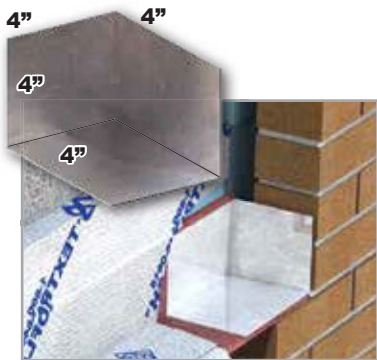

St/Steel End Dam

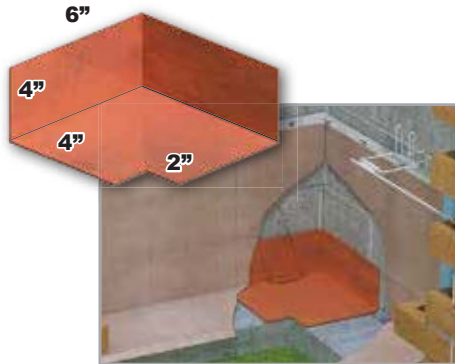

Copper Inside Corner

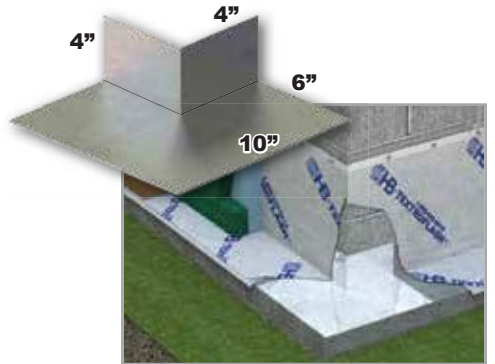

St/Steel Outside Corner

Termination Bars ●

For securing the top edge of flashing to the backup. Available in **T1 Standard** or **T2 with 3/8" flange** for easy caulking. Compatible with ALL H&B Membrane & Copper Laminate Flashings. Order with Foam-Tite[™] Seal to help fill irregularities between Termination Bar and the Substrate behind.

T1 - 1/8" X 1" X 8' long; available 304 or 316 ST/Steel, Aluminum or Plastic.

T2 - 26 ga. X 1-1/2" X 8' long; available 304 or 316 ST/Steel or Aluminum.

U.S. Patent: 6,945,000. Other Patents Pending.

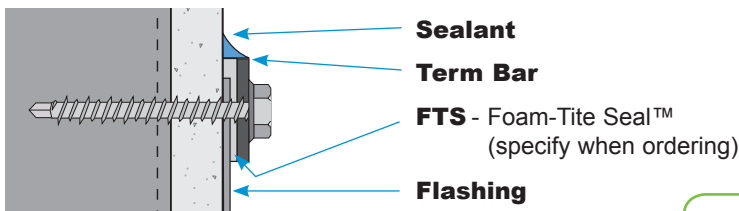

Type T1

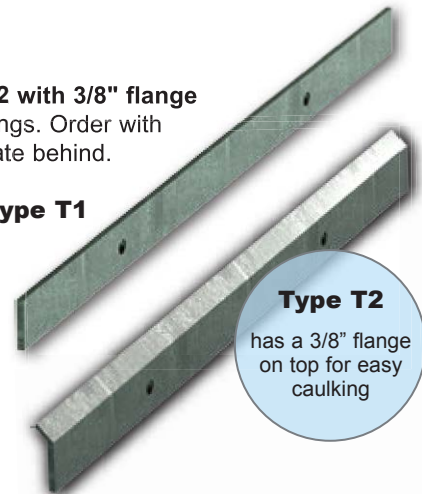

Type T2

has a 3/8" flange on top for easy caulking

Manufactured with an average of **60%** recycled content.

PRIMER-SA[™] Water-Based Primer for H&B Self-Adhesive Membranes

This water based primer imparts an aggressive, high tack finish on the treated substrate. It is specifically designed to facilitate tenacious adhesion of ALL H&B self-adhered membranes to numerous substrates such as CMU, glass faced sheathing, plywood and OSB. Primer-SA remains pressure sensitive, is fast drying and VOC compliant with no noxious fumes.

HB SEALANT Multi-Purpose Sealant with 25% Movement

Compatible with ALL H&B non-asphalt flashing's, HB Sealant is excellent for lapping and sealing flashing, drip edges, terminations, and end dams. It is effective in damp, dry, or cold climates and is free of solvents and isocyanates. HB Sealant can be applied in temperatures as low as 32°F and is UV resistant.



* **NOTE:** Hohmann & Barnard is not responsible for incompatibility of non-H&B primers, sealants, and flashings.

WEEP HOLES & MORTAR COLLECTION DEVICES

#341 Round Plastic Weep Holes #342 Rectangular Plastic Weep Holes

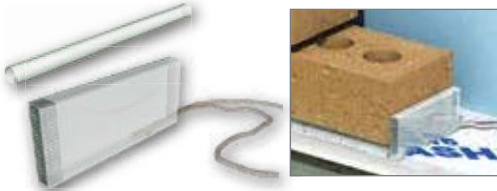

#341 Series Standard - 1/4" or 3/8" outside diameter x 4" long.

#342 Series Standard - 3/8" wide x 1-1/2" high x 3-1/2" long.

#341W & #342W Provided with cotton wick attached, for placement inside cavity.

#341S & #342S Provided with screen insert (Brass or Stainless Steel), to prevent infiltration of insects or debris.

#341W/S & #342W/S - Provided with both wick and screen.

#343 Louvered Weep Holes

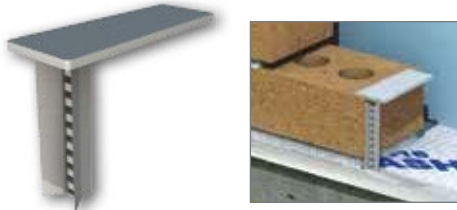

#343 Series Standard - 2-1/4", 2-7/8" or 3-1/2" high, injection-molded flexible PVC. Available only in Gray. Rectangular closer strip prevents mortar droppings from clogging openings. Compressible flanges for joint widths of 1/2" - 3/4".

Manufactured from **100%** post-industrial and/or post-consumer recycled material.

QV Quadro-Vent™



QV Standard: 3/8" x 3-3/8" x 2-1/2" high or **Jumbo:** 3/8" x 3-3/8" x 3-1/2" high
Other sizes available upon request.

Colors: Clear, Gray, White, Black, Buff, Cocoa or Almond

Honeycomb design restricts ingress of insects and other debris while allowing passage of moisture up to its 2-1/2" height, important in the event of mortar droppings at bottom of cavity. Also suitable for top of wall venting.

Mortar Web™

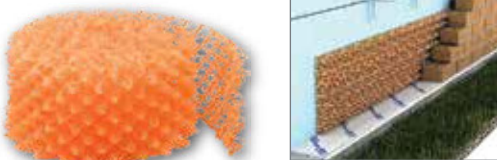

Mortar Web™ - 1" wide x 10" high x 50' long roll.
2" wide x 10" high x 25' long roll.

Suspends mortar droppings and redirects moisture to the exterior of the structure and avoids water from pooling within the wall. Manufactured from a heavy fiber weave that is more effective than pea gravel and will not promote mold, mildew or fungus like other mortar collection devices.

Mortar Trap™

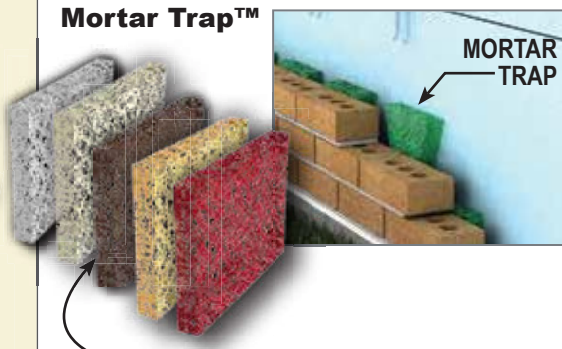

Mortar Trap™ - 0.4", 1", 1-1/2" or 2" thick x 10" high x 4' long.

High-density polyethylene (HDPE) strands woven into a 90% open mesh. Mortar Trap's unique shape breaks up and suspends mortar droppings to prevent blockage and allow water to flow freely to weep holes. Will not react to common building products such as PVC, polystyrene, copper, rubberized-asphalt or stainless steel and is inedible to insects.

Mortar Trap™ is slightly compressible and requires no fasteners, adhesives, special skills or tools making installation fast and easy.

MORTAR TRAP™ WEEP VENTS
also available, contact H&B for details

1" is manufactured from recycled material.

35%

2" is manufactured from recycled material.

50%

FLUID APPLIED AIR/VAPOR BARRIERS

ENVIRO-BARRIER™

Hohmann & Barnard's Enviro-Barrier™ is a single component, fluid applied, elastomeric membrane to provide an air, water and vapor barrier when applied to above-grade wall assemblies. It cures to form a resilient, monolithic, fully-adhered elastomeric membrane which meets & exceeds the highest industry standards for air barrier performance.

Features:

- Remains flexible over a wide temperature range.
- Cost effective, easy spray application.
- Asphalt-free formulation.
- Excellent adhesion to most construction materials including CMU, stone, gypsum board, wood, and metal.

• **ABAA Evaluated**

Product Data

COLOR	Dark blue
SOLIDS BY WEIGHT	65%
WEIGHT PER GALLON	10.2 pounds
COVERAGE RATE	25 sf/gal @ 60 mils wet (40 mils dry)
UV RESISTANCE	Up to 120 days
APPLICATION TEMPERATURE	40° – 120° F
DRY TIME	Tack Free: 2 – 4 hrs Full Cure: 4 – 24 hrs
PERFORMANCE TESTED	<ul style="list-style-type: none"> ■ ASTM E2178 ■ ASTM E96 ■ ASTM E2357 ■ NFPA 285



ENVIRO-BARRIER VP™

Enviro-Barrier VP™ is a single component fluid-applied elastomeric membrane to provide an air and water barrier when applied to above-grade wall assemblies. It cures to form a resilient, monolithic, fully-adhered membrane which resists air leakage and water penetration but allows vapor diffusion.



Product Data

COLOR	Light blue
SOLIDS BY WEIGHT	65%
WEIGHT PER GALLON	10.2 pounds
COVERAGE FOR CMU	60 sf/gal @ 25 mils wet
COVERAGE FOR EXT. SHEATHING	75 sf/gal @ 20 mils wet
UV RESISTANCE	Up to 120 days
APPLICATION TEMPERATURE	40° – 120° F
DRY TIME	Tack Free: 2 – 4 hrs Full Cure: 4 – 24 hrs
PERFORMANCE TESTED	<ul style="list-style-type: none"> ■ ASTM E2178 ■ ASTM E96 ■ ASTM E2357 ■ NFPA 285

* Please contact Hohmann & Barnard's technical department for specifications and test results.

AIR/VAPOR BARRIER PRODUCTS

X-BARRIER™ Peel and Stick Barrier

X-Barrier™ is a sheet-applied, self-adhesive membrane to provide an air and water barrier when applied to above-grade wall assemblies. X-Barrier meets and exceeds the highest industry standards for air barrier performance.

Features:

- Remains flexible over a wide temperature range.
- Asphalt-free formulation.
- Excellent adhesion to most construction materials including CMU, stone, wood, and metal.
- Available in 36" x 75' rolls.



Product Data

COLOR	White Sheet
ADHESIVE	High Temperature Non-Asphalt
THICKNESS	40 mils
UV EXPOSURE	180 Days
APPLICATION TEMPERATURE	Above 40° F
PERFORMANCE TESTED	<ul style="list-style-type: none"> ■ ASTM E2178 ■ ASTM E96 ■ ASTM E2357



ENVIRO-BARRIER™ Mastic

Trowel/Gun Grade Synthetic Mastic

Hohmann & Barnard's Enviro-Barrier™ Mastic* is a single component water-based flexible mastic designed to seal terminations, edges of patches and overlaps in detail areas.

Features:

- Excellent adhesion — bonds to substrate and remains permanently flexible.
- Fast Drying — allows for tight application schedules.
- VOC compliant — water-based and contains no hazardous or flammable solvents.
- Low odor — no noxious fumes.

PRIMER-SA™ also available, see pg 42.

*** NOTE:** Hohmann & Barnard is not responsible for incompatibility of non-H&B primers, mastics, and flashings.

WINDOW TAPES



1. **STRETCH-X-SEAL™** Window Pan / Detail Tape
2. **X-SEAL® MEMBRANE** Detail Tape for Doors & Windows
3. **ENVIRO-BARRIER™** Fluid Applied Air & Vapor Barrier (see pg 44)

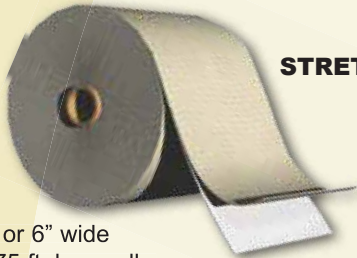

STRETCH-X-SEAL™

4" or 6" wide
x 75 ft. long rolls.

**X-SEAL®
MEMBRANE**



3", 4", or 6" wide
x 75 ft. long rolls.
Other widths (up to 36")
available upon request.



SPRAY-TAPE™

5 gallon pail. Coverage rate is
approximately 25 sf/gal @ 60 mil wet.

STRETCH-X-SEAL™

Stretchable Detail Tape

Stretch-X-Seal™ is a flexible, "stretchable", and tear-resistant flashing detail tape that allows for easy installation in awkward configurations such as I-beams, window pan openings, & other wall penetrations.

- A tough, long-lasting detail tape for window sills and penetrations that adapts to difficult shapes.
- Stretch-X-Seal™ is wrapped into the window pan opening before the window is installed, flashing the bottom corners at the window sill.
- Stretch-X-Seal™ provides superior moisture protection at the most vulnerable points of air and water intrusion.
- UV resistant for up to 120 days.

Patents Pending

X-SEAL® MEMBRANE

Detail Tape for Doors & Windows

X-Seal® Membrane Self-Sealing, Self-Adhering Detail tape provides a durable seal around doors and windows and can be used to seal joints, seams, holes and other undesirable openings in wall systems. It resists the elements with unfailing performance and prohibits harsh environmental conditions from invading a structure.

- Heavy-duty adhesive, made from a proprietary synthetic rubber compound, integrally bonded to a high strength woven polyethylene/polypropylene film.
- Will not rot, crack, or drool like rubberized-asphalt adhesives.
- UV resistant for up to 90 days.
- Asphalt-Free!

Patents Pending

SPRAY-TAPE™

Water-Based Liquid Detail Flashing for Air Barriers

Spray-Tape™ is a water based single component detail flashing for H&B air barriers. It is designed to seal door/window openings, terminations, edges of patches and overlaps in detail areas.

- Excellent adhesion – bonds to substrate and remains permanently pressure sensitive.
- Aggressive tack – provides a tenacious bond to substrates such as CMU, glass faced sheathing panels, plywood and OSB.
- Fast Drying – allows for tight application schedules.
- VOC compliant – water-based formula contains no hazardous or flammable solvents and has no noxious fumes.

Patents Pending

ALUMINUM BRICK VENTS

Extruded Aluminum

Manufactured from approximately **60%** recycled material.

Features

- Minimum .125" 6063-T5 alloy.
- Standard 204-RI clear anodized finish.*
- Overlapping blades, all at 45, with storm lip.
- Extruded stop for screen retention.
- Continuous weepage on bottom.
- Special custom sizes available.
- Lengths up to 8 ft. available without front mullions - continuous blade effect.
- Extruded vents can be readily made to any specified height or width without exposed mullions.

Style "E" 4" Deep	Style "F" 1-1/2" Deep with 1" Flange	Nominal Sizes W x H (see notes below)
E 825	F 825	8-1/8" x 2-3/8"
E 847	F 847	8-1/8" x 4-3/4"
E 808	F 808	8-1/8" x 7-3/4"
E 125	F 125	12" x 4-3/4"
E 128	F 128	12" x 7-3/4"
E 1212	F 1212	12" x 11-3/4"
E 157	F 157	15-5/8" x 7-3/4"
E 1516	F 1516	15-5/8" x 15-3/4"
E 162	F 162	16-1/2" x 2-3/8"
E 164	F 164	16-1/2" x 4-3/4"
E 168	F 168	16-1/2" x 7-3/4"
E 1616	F 1616	16-1/2" x 15-3/4"
E 244	F 244	24" x 4-3/4"
E 248	F 248	24" x 7-3/4"
E 3208	F 3208	32" x 7-3/4"
E 4808	F 4808	48" x 7-3/4"

Notes:

- "E" vents add 1/4" to nominal height for ribs.
- "F" vents add 1" face flange on 4 sides to nominal size.
- Add 1/4" to nominal width for mechanical fastener heads.
- Non-standard finishes include medium or dark bronze anodized, kynar or baked enamel*.

Cast Aluminum

Stytle "CA" 4" Deep	Nominal Sizes W x H (see notes below)
CA 825	8" x 2-1/4"
CA 847	8-1/4" x 4-15/16"
CA 808	8" x 7-7/8"
CA 123	12" x 2-3/4"
CA 124	12" x 3-1/2"
CA 125	12" x 5"
CA 128	12" x 7-3/4"
CA 162	16-1/2" x 2-3/8"
CA 1604	16" x 4"
CA 164	16" x 4-15/16"
CA 166	16" x 6"
CA 168	16" x 7-3/4"

Features

- Cast Aluminum with Mill finish*.
- Minimum .125" thick.
- Rear water stop.

Note:

Cast aluminum vents are standard in mill finish and do not contain mortar ribs.
*Also available in baked enamel at extra charge.

STYLE "E"



STYLE "F"



Mill finish*
Load bearing
Overlapping blades

STYLE "CA"



Note: All extruded and cast vents can be equipped with operable dampers & ducts

EXPANSION PRODUCTS

NS-Neoprene Sponge



NS-Neoprene Sponge is a closed-cell, non-absorbent horizontal and vertical joint filler used in a variety of masonry applications. Neoprene allows expansion and prevents clogging of joints with mortar.

Available 1/4", 3/8" or 1/2" thick x 3", 4" or 6" wide in 50' long rolls. Special widths and thicknesses available on request. Pressure-sensitive adhesive backing & tear-strip also available on request.

ASTM D 1056 Grade 2A 1

Note: Also available as solid rubber for bearing pad conditions ASTM D 2000 (60 durometer std).

Bearing Pads



Commercial Grade Bearing Pad is a black, dense, molded compound with high compressive strength, superior hardness characteristics and cold weather flexibility. Applications include skid pads, bumpers, roof pads, vibration control for heavy machinery, etc.

ASTM D2240

AASHTO Grade Bearing Pad is cut from a molded sheet of polychloroprene (neoprene), a synthetic rubber compound. It is used in steel beams, bridges, buildings, precast & prestressed concrete applications.

AASHTO Grade 60 (M251)

RS - RUBBER CONTROL JOINT

Extruded rubber material designed for masonry walls at control joints. Rubber material conforms to **ASTM D-2000 2AA-805**.

Available in 4ft lengths

VS - PVC CONTROL JOINT

The VS Series is a complete line of polyvinyl chloride control joints suitable for various wall conditions. PVC material conforms to **ASTM D 2287 (Type PVC 654-4)**.

Available in 4ft lengths

"Standard" and "Tee" versions are for use in Sash Blocks. "-8" and "-12" are for standard 8" & 12" Stretcher Blocks.

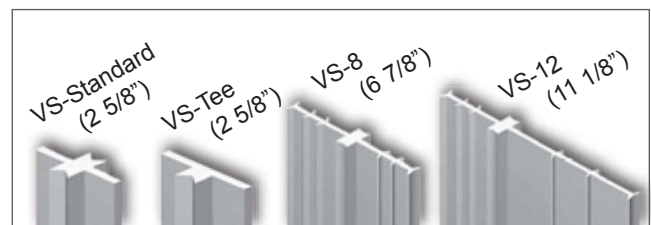
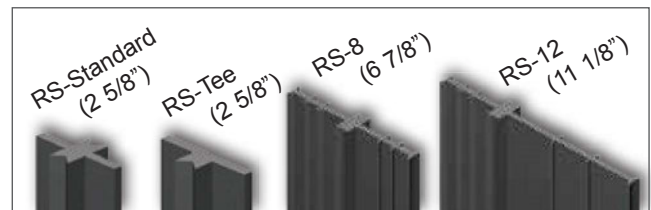

Manufactured from **50%** recycled material.

Available in 4 ft. lengths, 60 ft. per box (RS-12 & VS-12 are 48 ft. per box)

EXPANSION & CONTROL JOINTS

BACKER ROD

Backer Rod is an ideal non-absorbent, compressible backup material inserted into a joint to control sealant depth. It creates a backstop to allow proper sealant tooling and allows proper sealant of the joint surfaces. Backer Rod forms a proper bond between the back-up material and the sealant. It can also be used as a temporary joint seal.

Commonly used for glazing operations, window and door applications, expansion joints, curtain wall joints, partitions, log construction or pavement joints.

Standard Backer Rod is an extruded round, closed cell, low density polyethylene foam material with a skin-like outer texture. It is highly flexible and compressible for easy installation.

This material is compatible with butyl, polysulfide, acrylic, polyurethane, silicone and most other cold sealants.

Available in diameters from 1/4" to 6"



ASTM D1622
ASTM D1621
ASTM C5090
ASTM C335

SOFT ROD

Soft Rod is a closed cell material that is much lighter than standard Backer Rod. This allows for a product that is much lower in density and much easier to work with. It is compatible with butyl, polysulfide, acrylic, polyurethane, silicone and most other cold sealants.

Available Sizes: 3/8", 5/8", 7/8", 1 1/8", 1 1/2", 2", 2 1/2", 3" and 4" diameter.

ASTM D1622; ASTM D1621; ASTM C5090; ASTM C335



REMOVABLE EXPANSION JOINT CAP

This flexible, highly resilient polystyrene product is used to form and fill horizontal and vertical joint applications. It is ideal for molding concrete to maintain uniform edging. Before concrete placement, install on top of the existing expansion joint material to form precise horizontal and vertical intersections within the concrete. With little clean up, the removable top is then snapped off without any effort, and the result is a permanent channel, ready to receive caulk or sealant. Use at any depth, as well as with any other expansion joint product. When installed correctly Expansion Joint Caps require no further maintenance.

Available Sizes: 1/2" x 1/2", 3/4" x 1/2", 1" x 1/2" X 10' lengths.
50 pieces per box.



CORK PRODUCTS

STANDARD CORK

Standard Cork sheets are molded to desired thickness under heat and pressure. Standard Cork is highly resilient, will compress without extrusion, and recover to 95% of original thickness. It is low maintenance, easily handled and can be painted to match surrounding surfaces.

Standard Cork is suggested for use where it is essential that the joints be kept sealed at all times, such as in sewage treatment plants, flood walls, spillways, filtration plants and in numerous commercial and industrial applications. Recommended and compatible with all hot-pour and cold-applied joint sealants.

Note: Standard Cork is an inert, nonabsorbent, rot-proof filler.

Thickness: 1/8" - 2"*

Width: Up to 36" in 1/2" increments

Length: 5' and 10'

*Custom sizes - available upon request



85% Rapidly Renewable Resource



ASTM D 1752, TYPE II
AASHTO M153, TYPE II

Standard Cork is a Rapidly Renewable Resource. It is harvested in an environmentally friendly process during which not a single tree is cut down. Cork is the bark that is scraped off the Cork Oak tree. The bark renews itself for the next harvesting and will continue to produce cork for the rest of its lifetime. It is both renewable and biodegradable.

SELF-EXPANDING CORK

Self-Expanding Cork is pre-molded expansion joint filler for concrete. Self-Expanding Cork is pre-compressed at the factory under heat and pressure. This process permits the cork to expand up to 140% of its original thickness.

Self-Expanding Cork can be used in all concrete joints subject to excessive contraction, as could occur in dams, sewage treatment plants, waste water plants, flood walls, spill ways, and power plants. Material will not expand prematurely under normal atmospheric conditions and can thus be field cut on site to the required size. The convenient 3' x 5' sheet size is easy to handle.



ASTM D 1752, TYPE III
AASHTO M153, TYPE III

Field Installation is not compromised by butting together broken pieces with rough edges.

Self-Expanding Cork is wrapped in moisture-proof paper. The factory packaging should not be opened until cutting and/or installation is required. Do not expose to rain or moisture after opening. Self-Expanding Cork will not prematurely expand under normal atmospheric conditions.

Thickness: 1/8", 1/4", 3/8", 1/2", 3/4", 1" *

Width: Up to 36" in 1/2" increments

Length: 5'

*Custom sizes - available upon request

WIRE

MATERIALS:

Carbon steel wire: ASTM A1064/A1064M
(Tensile Strength - 80,000 psi)

Steel wire for masonry joint reinforcement:
ASTM A951/A951M - TMS 402-13/ACI 530-13/ASCE 5-13

FINISHES:

Brite Basic:
no coating

Mill Galvanized:
ASTM A641/A641M (0.1 oz/ft²)
ASTM A641/A641M (0.4 oz/ft²) and ASTM A641/A641M
(0.8 oz/ft²) available on special order

Hot Dipped Galvanized:
ASTM A153/A153M-B2 (1.5 oz/ft²)

Stainless Steel:
ASTM A580/A580M - AISI Type 304 (316 on special order)

DIAMETER:

9 Gauge (.148" or W1.7)
3/16" (.187" or W2.8)

SHEET STEEL ITEMS

MATERIALS:

Carbon Steel Sheets: ASTM A1008/A1008M

FINISHES:

Mill Galvanized:
ASTM A653/A653M Class G60 (0.6 oz/ft²)

Hot Dipped Galvanized:
ASTM A153/A153M-B2 (1.5 oz/ft²)

Stainless Steel:
ASTM A666, ASTM A480/A480M, and
ASTM A240/A240M – AISI Type 304 (316 on special order)

HOHMANN & BARNARD recommends using type 304 or 316 Stainless Steel in all building projects to protect against corrosion and limit thermal transfer in the wall cavity. Please visit www.h-b.com for the most up to date technical information.

EFFECTIVE STEEL AREA (IN²)

	4" wall	6" wall	8" wall	10" wall	12" wall	14" wall	16" wall
#120 Truss							
Standard - 9ga. S/R x 9ga. C/R	.051	.050	.048	.047	.045	.044	.043
Extra Heavy - 3/16" S/R x 9ga. C/R	.072	.071	.069	.068	.066	.065	.064
Super Heavy Duty - 3/16" S/R x 3/16" C/R	.073	.072	.070	.069	.067	.066	.065
#220 Ladder							
Standard - 9ga. S/R x 9ga. C/R	.0345	.0345	.0345	.0345	.0345	.0345	.0345
Extra Heavy - 3/16" S/R x 9ga. C/R	.0554	.0554	.0554	.0554	.0554	.0554	.0554
Super Heavy Duty - 3/16" S/R x 3/16" C/R	.0554	.0554	.0554	.0554	.0554	.0554	.0554

IMPORTANT: Since each construction project is unique, the appropriate selection and use of any product contained herein must be determined by competent architects, engineers and other appropriate professionals who are familiar with the specific requirements of the project in question.

This catalog is intended as a design aid for use in North America, and on projects world-wide where North American design parameters have been used.

The information in this catalog is provided in good faith. However, anchor and tie adequacy can be adversely affected by on-site workmanship and varying conditions in different geographic locations for which Hohmann & Barnard can accept no responsibility. Similarly, should Hohmann & Barnard products be used in conjunction with channels or components from other manufacturers, there can be no guarantee of performance.

All application illustrations shown in the catalog are for guidance only and should not be taken as working drawings. Hohmann & Barnard reserves the right to amend, withdraw or to make changes to products and specifications at anytime without written notice to customers, designers and users.

It is the policy of Hohmann & Barnard to work with designers, engineers and contractors in providing suggestions and advice for the satisfactory solution of anchoring problems. However, all advice and drawings provided are subject to the approval of the design team, contractor and structural engineer, who take ultimate responsibility for proper product usage.



HOHMANN & BARNARD, INC.
a MiTek company

CORPORATE HEADQUARTERS

30 Rasons Court
Hauppauge, NY 11788
p 631-234-0600 :: f 631-234-0683

BRANCH OFFICES

Alabama	205-956-0046
Illinois	773-586-6700
Maryland	410-290-9310
Texas	817-625-9781
Utah	801-973-6408

SUBSIDIARIES

Diedrich Technologies
New York 518-357-9757

RKL Building Specialties
New York City 718-728-7788

Blok-Lok, Ltd.
Ontario, Canada 905-266-2277

www.h-b.com

weanchor@h-b.com

800.645.0616



Keep up to date on our ever-evolving product line: visit www.h-b.com

Hohmann & Barnard is concerned about the environment. For further information regarding LEED certification or the recycled content of our products please contact us.

'USGBC' and related logo are trademarks of the U.S. Green Building Council and are used by permission.



Printed in the USA.
Please pass this catalog on or recycle it.

© 2016 All Rights Reserved.